



SmartStar[®] iEQ45[™]
With Go2Nova[™] 8407 Hand Controller

Instruction Manual

Products #8000D/#8000DP

Table of Content

Table of Content	2
1. iEQ45™ German Equatorial Mount Overview	4
2. iEQ45™ Mount Assembly	5
2.1. Parts List	5
2.2. Assembly Terms	6
2.3. iEQ45 Ports	7
2.4. Go2Nova® 8407 Hand Controller	8
2.4.1. Key Description	8
2.4.2. The LCD Screen	9
3. iEQ45™ Mount Assembly	11
3.1. Introduction	11
3.2. iEQ45 Assembly	11
3.2.1. STEP 1. Setup Tripod	12
3.2.2. STEP 2. Attach the EQ mount	12
3.2.3. STEP 3. Set The Latitude	13
3.2.4. STEP 4. Attach Counterweight (CW) Shaft	14
3.2.5. STEP 5. Connect Cables	14
3.2.6. STEP 6. Setup Hand Controller	14
3.2.7. STEP 7. Polar Alignment	16
3.2.8. STEP 8. Install Counterweight(s)	18
3.2.9. STEP 9. Attach and Balance an OTA on the Mount	19
4. Getting Started	21
4.1. Setup the Mount and Polar Alignment	21
4.2. Manual Operation of the Mount	21
4.3. Initial Star Alignment	21
4.4. Go to the Moon and Other Stars	21
4.5. Star Identifying Function	21
4.6. Turn Off the Mount	22
5. Complete Functions of Go2Nova® Hand Controller	23
5.1. Slew to an Object	23
5.1.1. Solar System	23
5.1.2. Deep Sky Objects	23
5.1.3. Stars:	23
5.1.4. Constellations	23
5.1.5. Comets	23
5.1.6. Asteroids	24
5.1.7. User Objects	24
5.1.8. Enter R.A. DEC	24
5.2. Sync to Target	24
5.3. Set Up Controller	24
5.3.1. Set Up Time & Site	24
5.3.2. Set Display and Beep	24
5.3.3. Set Anti-backlash	24
5.3.4. Meridian Treatment	25
5.3.5. Set Eyepiece Light	25
5.3.6. Heating Controller	26
5.3.7. Upgrade RA & DEC	26
5.3.8. Firmware Information	26

5.4. Align.....	26
5.4.1. Polar Alignment.....	26
5.4.2. SolarSys Alignment.....	26
5.4.3. One-Star Alignment.....	26
5.4.4. Multi-Star Alignment.....	27
5.4.5. Test Backlash.....	27
5.4.6. Pole Star Position.....	28
5.5. PEC Option.....	28
5.5.1. PEC Playback.....	28
5.5.2. Record PEC.....	28
5.5.3. System Self-Test.....	28
5.6. Set Tracking Rate.....	29
5.7. Set User Objects.....	29
5.8. Guide Options.....	30
5.8.1. Set Guider Rate.....	30
5.8.2. Guide Port Direction.....	30
5.9. Set Slewing Rate.....	31
5.10. Park Scope.....	31
5.11. To Zero Position.....	31
5.12. Balance Test.....	31
6. Maintenance and Servicing.....	33
6.1. Maintenance.....	33
6.2. iOptron Customer Service.....	33
6.3. Product End of Life Disposal Instructions.....	33
6.4. Battery Replacement and Disposal Instructions.....	33
Appendix A. Technical Specifications.....	34
Appendix B. Go2Nova® 8407 HC MENU STRUCTURE.....	35
Appendix C. Firmware Upgrade.....	38
Appendix D. Computer Control an iEQ45 Mount.....	45
Appendix E. Go2Nova® Star List.....	46
IOPTRON TWO YEAR TELESCOPE, MOUNT, AND CONTROLLER WARRANTY.....	53



WARNING!

***NEVER USE A TELESCOPE TO LOOK AT THE SUN WITHOUT A PROPER FILTER!
Looking at or near the Sun will cause instant and irreversible damage to your eye.
Children should always have adult supervision while observing.***

1. iEQ45™ German Equatorial Mount Overview

The iEQ45 is one of the new breed of premium astro-imaging equatorial mounts from iOptron. The iEQ45 offers the next generation GOTO technology from iOptron. The mount is made of the highest quality materials to ensure stability and durability. With a payload of 45 lb (20 kg) balanced – it comes standard with a calibrated dark field illumination polar scope and a sturdy 2-inch stainless steel tripod. It also fits both Vixen and Losmandy-type mounting plates. Its lighter weight (only 25 lb or 11.4 kg) makes it much easier to carry.

Features:

- Specialized astrophotography mount ideal for entry-level and intermediate astrophotographers
- Portable, compact, and sturdy German equatorial mount with the highest Payload/Mount ratio (1.7) in the category
- Payload: 45 lb (20 kg) (excluding counterweight)
- Mount weight: 25 lb (11.4 kg)
- Ultra-accurate tracking with temperature-compensated crystal oscillator (TCXO)
- FlexiTouch™ Gap-free structure for both R.A. and DEC worm gears
- Angular contact bearing for R.A and DEC axles
- Resolution: 0.09 arc second
- Go2Nova® 8407 controller with Advanced GOTO NOVA® GoTo Technology
- Permanent periodic error correction (PEC)
- Built-in 32-channel Global Positioning System (GPS)
- Integrated autoguiding port capable of reverse guiding with auto-protection
- AccuAligning™ polar scope with dark-field illumination and Quick Polar Alignment procedure, allowing fast and accurate polar alignment
- BrightStar Polar Alignment routine for those who can't see the Pole Star
- iOptron port for electronic focuser, laser pointer, planetary dome control
- RS232 port for computer control via ASCOM platform
- Heated hand controller for low temperature operation (as low as -20°C)
- Spring loaded Vixen/Losmandy dual saddle
- 2 inch heavy-duty stainless steel tripod or 48" tall pier
- Die-cast metal tripod spreader with accessory tray
- Optional counterweight extension shaft (#8026)
- Optional carrying case (#8080)
- Optional PowerWeight™ rechargeable battery pack (#8128)
- Optional AZ base (#8050) to convert it to an AltAzimuth mount.

2. iEQ45™ Mount Assembly

2.1. Parts List

There are two shipping boxes for a regular tripod version. One box contains an EQ mount, an 8407 hand controller, a Vixen/Losmandy dual dovetail saddle (attached to the mount). One box contains a tripod, two 11lb (5kg) counterweights (CWs) and accessories.

A pier version has three boxes, a mount box, a pier box and an accessory box with 2 CWs and accessories.

Other parts included in the package¹:

- 6P6C RJ11 coiled controller cables X2
- Illuminating LED with cable
- AC adapter (100V~240V)
- 12V DC adapter cable with car lighter plug
- RJ9 to RS232 serial cable for hand controller firmware upgrade
- RS232 cable
- Azimuth locking T-bolts X2 or azimuth screws X3

ONLINE CONTENTS (click under “Support” menu) [**www.iOptron.com**](http://www.iOptron.com)

- Quick Start Guide
- This manual
- Tips for set up
- Hand controller and mount firmware upgrades (check online for latest version)
- ASCOM driver
- Reviews and feedback from other customers

¹ US market only. Actual contents may vary.

2.2. Assembly Terms

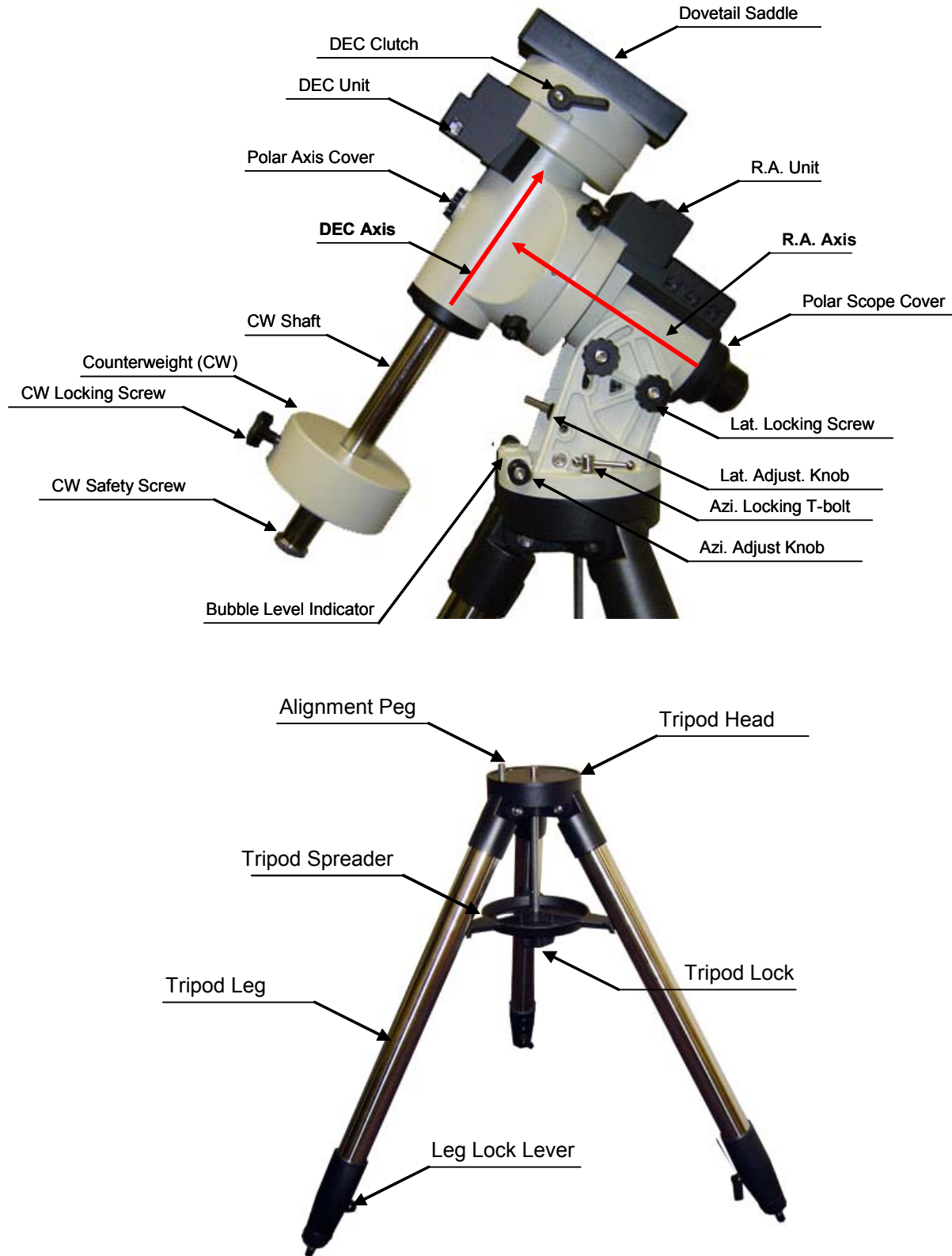

Figure 1. iEQ45 assembly terms (mount and tripod)

2.3. iEQ45 Ports

Ports on Main Control Unit



Figure 2. Ports on main control unit

- Dec: For connecting to DEC driver unit
- iOptron port: For connecting to other iOptron accessories, such as an electronic focuser, a laser pointer, or a planetary dome control
- HBX (Hand Box): For connecting to the 8407 Hand Controller
- Reticle: Power supply for the Polar Scope dark field illumination LED
- Power DC 12V: AC adapter power plug
- ON/OFF Switch: Power switch
- Guide: Autoguiding port for ST-4 compatible guiding cameras
- RS232: Series port for ASCOM control and main board, R.A. and DEC unit firmware upgrade

Port on DEC Unit

The only port on the DEC unit is used to connect to the Dec port on main control unit.

2.4. Go2Nova[®] 8407 Hand Controller



Figure 3. Go2Nova 8407 hand controller

The Go2Nova[®] 8407 hand controller (HC) shown in Figure 3 is the standard controllers that used for the iEQ45 mount. It has an integrated temperature controller that ensures it can be operated below 20°C (-4°F). It has a large LCD screen, function keys, direction keys and number keys on the front; a red LED reading light on the back; and a HBX port (6-pin) and a serial port (4-pin) at the bottom.

2.4.1. Key Description

- MENU Key: Press “MENU” to enter the Main Menu.
- BACK Key: Move back to the previous screen, or end/cancel current operation, such as slewing.
- ENTER Key: Confirm an input, go to the next menu, select a choice, or slew the telescope to a selected object.
- Arrow (▲▼◀▶) Keys: The arrow keys are used to control the movement of DEC and R.A. axes. Press and hold ▲(DEC+),▼(DEC-) buttons to move a telescope along the DEC direction, ◀(R.A.+), ▶(R.A.-) to move a telescope along the RA direction. They are also used to browse the menu or move the cursor while in the menu. **Holding an arrow key for a fast scrolling.**
- Number Keys: Input numerical values. Also used to adjust speeds (1: 1X; 2: 2X; 3: 8X; 4: 16X; 5: 64X; 6: 128X; 7: 256X; 8: 512X; 9: MAX)
- Light Key(☀): Turns on/off the red LED reading light on the back of the controller.
- ? Key: Identify and display bright stars or objects where the telescope points to.
- STOP/0 Key: Stop the mount during GOTO. Also toggling between start and stop tracking.
- HBX (Handbox) port: connect the HC to the iEQ30 mount using a 6-wire RJ11 cable.

- Serial port: connect the HC to a Computer via a RS232 to 4-wire RJ-9 cable. The pin out of the serial port is shown in Figure 4.

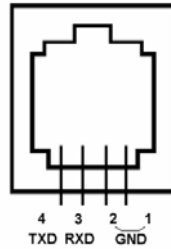

Figure 4. Serial port pin out on an 8407 hand controller

2.4.2. The LCD Screen

The 8407 HC has a large 8-line, 21-character per line LCD screen, which displays all the information as shown in Figure 5. The user interface is simple and easy to learn.

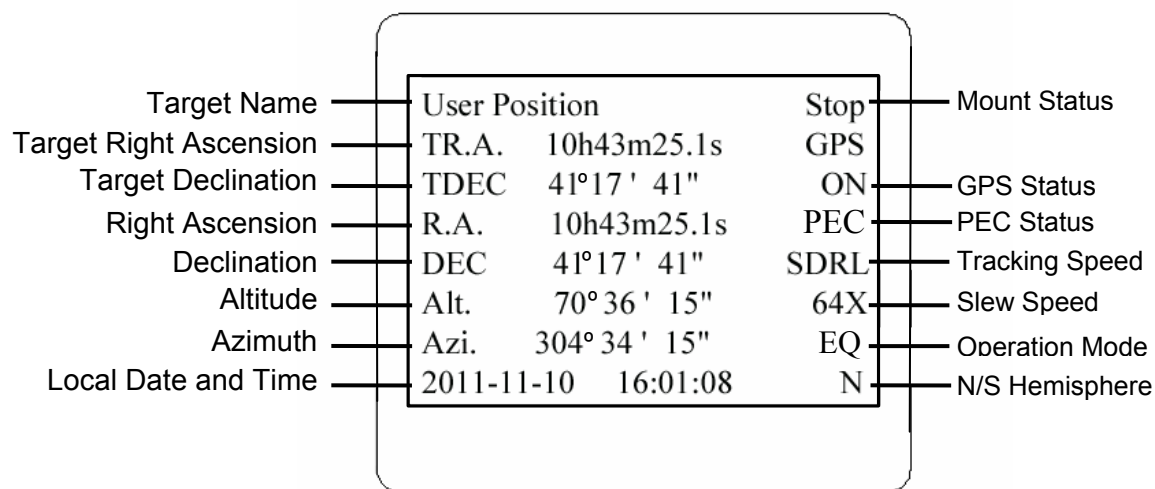

Figure 5. 8407 HC LCD Information Screen

- Target Name/Mount Position: displays the name of the target that telescope is currently pointed to or the current mount position.
 - Zero Position: The position when the mount is turned on. Or the mount is moved to Zero Position using **"To Zero Position"** command;
 - User Position: The mount is point to a user defined position, which could be a real sky object or just simply due to press an arrow key.
 - An object name, such as "Mercury" or "Andromeda Galaxy": Name of the Star or celestial object that the mount is currently slewing to, GOTO or tracking;
 - Park Position: One of two positions that you park the scope using **"Park Scope"** command.
- Target R.A.: Right Ascension of the target object.
- Target Declination: Declination of the target object.
- Right Ascension: Right Ascension of the telescope, or R.A.
- Declination: Declination of the telescope, or DEC.
- Altitude: Altitude of the telescope (degrees vertical from the local horizon - zenith is 90°).
- Azimuth: Azimuth of the telescope (north is 0°, east 90°, south 180°, and west 270°).
- Local Date and Time: display local time in a format of YY-MM-DD HH:MM:SS.

9. Mount Status: Display current operation status of the mount.
 - Stop: mount is not moving;
 - Slew: mount is moving with an arrow key is pressed;
 - GoTo: mount is slewing to a celestial object using "Select and Slew";
 - Busy: mount is busy slewing to some predefined position, such as Zero Position.
10. GPS status: When the power is turned on, it shows "GPS ON", which means a GPS receiver is properly connected. When the GPS receiver finds the satellites and receives the GPS signal, it shows "GPS OK". The "GPS OK" may turn off after few minutes to save power.
11. PEC status: Display of "PEC" here Indicates the PEC playback is turned on. Default is off.
12. Tracking speed: Display current tracking status of the mount
 - SDRL: mount is tracking at a sidereal speed;
 - Solar: mount is tracking at a solar speed;
 - Lunar: mount is tracking at a lunar speed;
 - King: mount is tracking at a king speed;
 - CSTM: mount us tracking at a customer defined speed.
13. Slew speed: It has 9 speeds: 1X, 2X, 8X, 16X, 64X, 128X, 256X, 512X, MAX (~4°/sec, depends on power source).
14. Operation Mode: Indicate if the mount is set at EQ or A/A mode

3. iEQ45™ Mount Assembly

3.1. Introduction

You have just purchased a telescope mount that is capable of taking you to a new level of astronomy. No matter which telescope or optical tube assembly (OTA) you select to install on the mount, the overall performance will be greatly enhanced. In order for you to get the optimum performance from the mount and OTA combination, you must assemble and adjust the mount correctly. The following fundamentals of telescope mounts are included to help you understand the big picture before you get into the specific details of the iEQ45 mount.

Telescope mounts are either equatorial mounts or altitude-azimuth (Alt-Az) mounts. Both types of mounts rotate the OTA around two perpendicular axes to point to a desired object in the night sky. An equatorial mount has the right ascension (R.A.) axis aligned with the celestial North Pole (CNP), or celestial South Pole (CSP), to provide rotation matching the celestial sphere rotation around the Earth and the declination axis (DEC) to provide elevation relative to the celestial equator. Since all celestial objects appear to rotate around the CNP, the R.A. axis allows the OTA to rotate with the celestial sphere and provide accurate tracking for visual observations and astrophotography. R.A. is the celestial equivalent of longitude. Like longitude, R.A. measures an angle that increases toward the East as measured from a zero reference point on the celestial equator. An Alt-Az mount has a horizontal axis to provide vertical (altitude) OTA movement from the local horizon and a vertical axis to provide horizontal (azimuth) OTA movement, similar to compass headings. An Alt-Az mount can provide tracking that is good enough for visual observing and short exposure photos, but not good enough for serious astrophotography. Alt-Az mounts require star alignments for the OTA to track stars and they do not have adjustment components on the mount. Equatorial mounts require alignment of the mount components as well as star alignments for accurate OTA tracking.

In order to provide the required Polar Axis alignment, equatorial mounts use a combination of both mount types described above. The adjustable part of the mount moves in the Alt-Az mode in order to align the R.A. axis, also known as the mount's Polar Axis, with the CNP. These Polar Axis adjustments do not involve any rotations of the OTA about the R.A. or DEC axes and can be performed without the OTA installed. The first step is to make an approximate azimuth alignment of the Polar Axis by aligning the specified tripod leg or reference point toward True North using a compass for reference (you must allow for the variation between True and Magnetic North at your location). Precise horizontal alignment of the Polar Axis is accomplished with azimuth adjustments on the mount. The second step is to adjust the Polar Axis vertically (altitude) above the North horizon by setting the observer's latitude on the provided latitude scale. This procedure is based on the fundamental geometry of the Earth's coordinate system in conjunction with the concept of the celestial sphere. You can verify this by visualizing yourself at the North Pole (latitude N90°) and Polaris will be 90° from the horizon, or directly overhead. These steps will place the Polar Axis very close to the CNP. Both of the above adjustments can be enhanced by the use of an opening along the R.A. axis that allows direct viewing of the North Star and the use of a polar scope to view through this opening. If you are going to get the most out of your equatorial mount it is essential to understand the concept of the Polar Axis and how the equatorial mount helps you establish and maintain a true Polar Axis alignment. Now, you are ready to perform star alignments using the equatorial mount's electronic controller and enjoy the night sky.

The iEQ45 mount is a next-generation equatorial mount that provides the precision alignment capabilities required for today's complete astronomy solution. The following sections of this manual provide the detailed steps required to successfully set up and operate the iEQ45 mount.

3.2. iEQ45 Assembly

NOTE: The iEQ45 is a precision astronomical instrument. It is highly recommended that you read the entire manual and become familiar with the nomenclature and function of all components before starting the assembly.

3.2.1. STEP 1. Setup Tripod

Expand the tripod legs and install the Tripod Spreader using the Tripod Lock as shown in Figure 6. Tightening the Tripod Lock will expand the tripod legs fully and provide maximum support for the mount and the Optical Tube Assembly (OTA). Adjust the tripod height by unlocking the tripod Leg Lock Levers, sliding the lower tripod leg to the desired length, and relocking the tripod Leg Lock Screws. It is recommended that you extend the legs fully during the first assembly and modify the length as required in subsequent adjustments. After the legs are adjusted and locked, stand the tripod with the Alignment Peg facing True North. If you are located in the southern hemisphere, face the Alignment Peg True South.

CAUTION: If the latitude of your location is below 20°, you may move the Alignment Peg to the opposite position to prevent the counterweights from hitting the tripod legs. If the latitude is below 10°, a pier (#8030, 48" tall or #8033, 42" tall) is recommended in place of a tripod. Or you may add a MiniPier (#8032). The mount can also be specially modified for the application near the equator.



Figure 6 Tripod

3.2.2. STEP 2. Attach the EQ mount

Carefully remove the mount from the shipping box and familiarize yourself with the components shown in Figure 1. Unlock the four (4) R.A. Clutch Screws and rotate the mount 180° around the R.A. axis to move the dovetail saddle face topside to the highest vertical position as shown in Figure 7. Tighten the R.A. Clutch Screws.

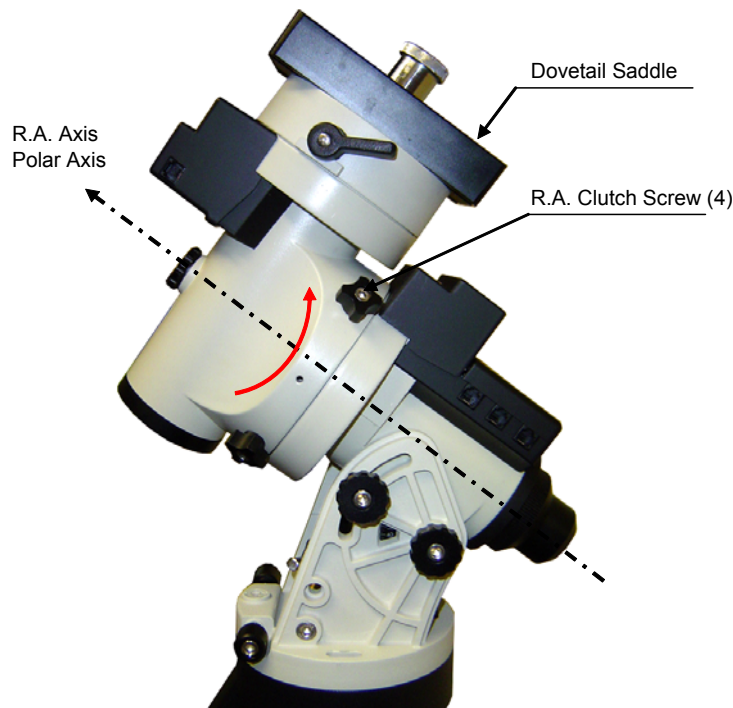

Figure 7 Rotating mount head

Retract the Azimuth Adjustment Knobs (next to the Bubble Level Indicator) to allow enough clearance for the Alignment Peg seating in the house. Put the mount onto the tripod head with bubble level on top of the Alignment Peg. Secure the mount head by tightening two Azimuth Locking T-bolts (or Screws

for some models). Level the mount by adjusting individual tripod leg. You may use the build-in Bubble Level Indicator or an external torpedo level to check level.

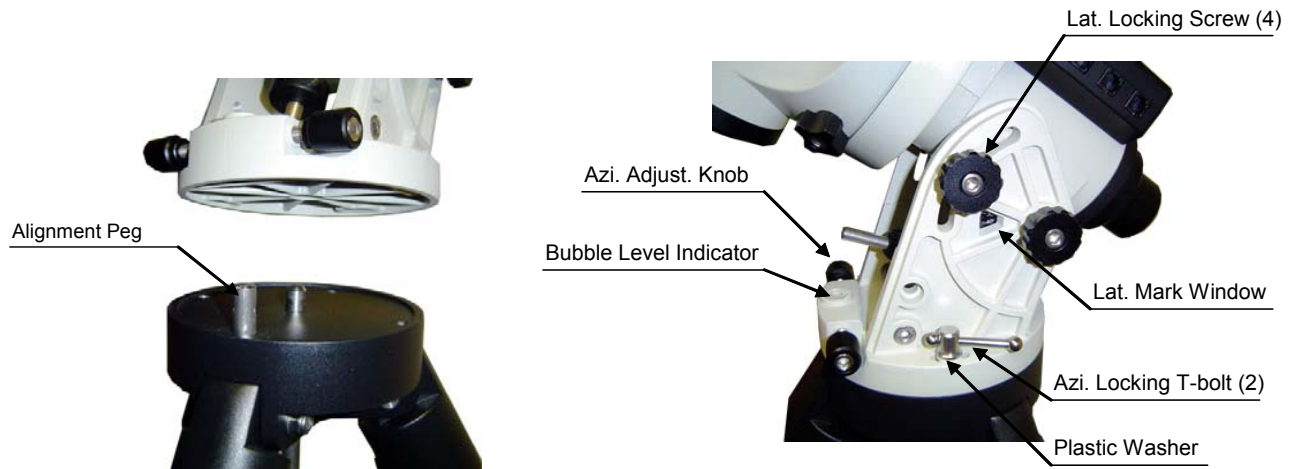

Figure 8 Install mount head

3.2.3. STEP 3. Set The Latitude

This step requires you to know the latitude of your current location. This can be found from your 8407 hand controller after the embedded GPS receives the signal from the satellites. It also can be easily found on the Internet, with your GPS navigator or a GPS capable cell phone. You will have to change this latitude setting every time you significantly change your night sky viewing location. This setting directly affects the mount's tracking and GOTO accuracy.

Loosen Latitude Locking Screws a little. Unscrew the Altitude Adjustment Lever from Altitude Adjustment Knob. Turn the Latitude Adjustment Knob to set your current Latitude, which is displayed in Latitude Mark Window, as shown in Figure 8. Use the Lever for fine adjustments as needed. Always set the latitude without the load.

The iEQ45 mount is equipped with two positions for the Latitude Adjustment Knob as shown in Figure 9, an upper position and a lower position. If the latitude of your location is between 5° and 40°, set the Latitude Adjustment Knob to the lower position. A Latitude Safety Block has to be installed. If the latitude of your location is between 35° and 70°, remove the Latitude Safety Block and set the Latitude Adjustment Knob to the upper position.

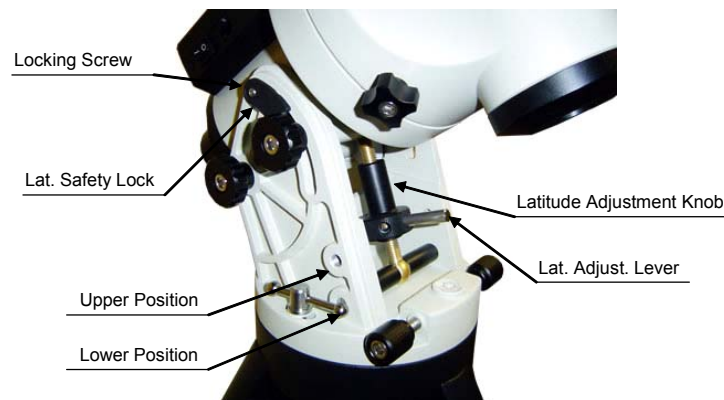

Figure 9 Latitude adjustment

CAUTION: If your location latitude requires changing the Latitude Adjustment Knob position, change the knob position before attaching the mount to the tripod.

3.2.4. STEP 4. Attach Counterweight (CW) Shaft

Unscrew the CW shaft from the top of the mount as shown in Figure 10(a) and thread it into the opening of the DEC axis as shown in Figure 10(b).

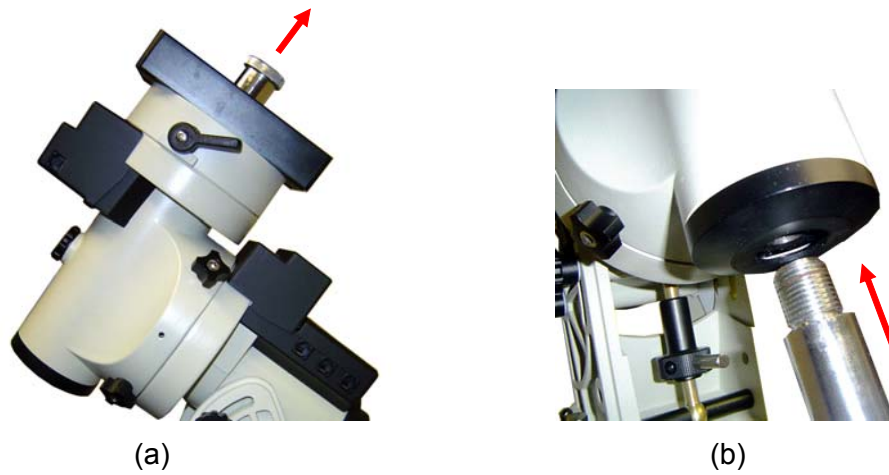

Figure 10

3.2.5. STEP 5. Connect Cables

Attach one end of an RJ11 cable into the socket on the side of the DEC unit and the other end into the DEC socket located on the main control unit. Using another RJ11 cable, connect the hand controller and the HBX socket located on the main control unit. Plug the 12V DC power supply into the Power socket on the main control unit. The red LED will illuminate when the power switch is turned on.

3.2.6. STEP 6. Setup Hand Controller

The iEQ45 is equipped with a GPS receiver, which will receive the time, longitude and latitude information from satellites after the link is established. A clear sky outside is needed for the GPS to establish its link with the satellites and change the display from **GPS ON** to **GPS OK**. Remove the OTA if it takes longer than expected to be connected to satellites.

Press MENU button, from the main menu, scroll down and select “**Set Up Controller**”

```
Select and Slew
Sync. to Target
Set Up Controller
Align
PEC Option
Set Tracking Rate
Set User Objects
Guide Options
```

Press ENTER and select “Set Up Time and Site”

```
Set Up Time and Site
Set Display and Beep
Set Anti-backlash
Meridian Treatment
Set Eyepiece Light
Heating Controller
Upgrade R.A. and DEC
Firmware Information
```

Press ENTER. A time and site information screen will be displayed:

```
2011-11-10 12:01:36
Daylight Saving Time    N
300 Min. behind    UT

Longitude:W071d08m50s
Latitude:  N42d30m32s

Northern Hemisphere
```

Local Time Set

The time will be updated automatically when the GPS has picked up a signal. You also can manually input the time information in case GPS does not function. Use the ◀ or ▶ key to move the cursor █ and use number keys to change the numbers. Use the ▲ or ▼ button to toggle between “Y” and “N” for Daylight Saving Time. Hold on the arrow key to fast forward or rewind the cursor.

In order to make hand control reflect your correct local time, time zone information has to be entered. Press ◀ or ▶ key, move the cursor to the third line “300 Min. behind UT” to set the time zone information (add or subtract 60 minutes per time zone). Enter minutes “ahead of” or “behind” UT (universal time). For Example,

- Boston is 300 minutes “behind” UT
- Los Angeles is 480 minutes “behind” UT
- Rome is 60 minutes “ahead of” UT
- Beijing is 480 minutes “ahead of” UT
- Sydney is 600 minutes “ahead of” UT

All the time zones in North America are *behind* UT, as shown in the following table. So make sure it shows “behind” instead of “ahead of” UT.

Time Zone	Hawaii	Alaska	Pacific	Mountain	Central	Eastern
Hour behind UT	-10	-9	-8	-7	-6	-5
Enter Minutes	600	540	480	420	360	300

To adjust minutes, move the cursor to each digit and use the number keys to input number directly. To change the “behind” or “ahead of” UT, move the cursor to “ahead” and using ▲ or ▼ key to toggle between “behind” and “ahead of”. When the number is correct, press ENTER and go back to the previous screen.

For other parts of the world you can find your “time zone” information from internet. **DO NOT COUNT DAYLIGHT SAVING TIME** for UT offset. Fraction time zone can be entered as well.

Observation Site Coordinate Set

The longitude and latitude coordinates will be automatically updated when the GPS picks up satellite signals. “W/E” means western/eastern hemisphere; “N/S” means northern/southern hemisphere; “d” means degree; “m” means minute; and “s” means second.

If for any reason your GPS can’t pick up a signal, you can manually enter the GPS coordinates. Press ◀ or ▶ key to move the cursor and using ▲ or ▼ key to toggle between “W” and “E”, “N” and “S”, using number key to change the numbers. It is always a good idea to do your home work to get the GPS coordinates before traveling to a new observation site.

The site coordinates information can be found internet, or from *Support* section in iOptron website, under *Controller Set-up* (<http://www.ioptron.com/support.cfm?module=faq#>). By entering the city name or address, you can find its latitude and longitude. In case you only find the site information in decimal format you can convert them into d:m:s format by multiplying the decimal numbers by 60. For example, N47.53 can

be changed to N47°31'48": $47.53^\circ = 47^\circ + 0.53^\circ$, $0.53^\circ = 0.53 \times 60' = 31.8'$, $0.8' = 0.8 \times 60'' = 48''$. Therefore, $47.53^\circ = 47^\circ 31' 48''$ or 47d31m48s.

N/S Hemisphere Selection

If the polar axis is aligned to North Celestial Pole, then set the mount to Northern Hemisphere. If the polar axis is pointing to South Celestial Pole, set the mount to Southern Hemisphere. Press ◀ or ▶ key to move the cursor and using ▲ or ▼ key to toggle between "Northern Hemisphere" and "Southern Hemisphere".

Select Northern Hemisphere if you are located in US and press ENTER to go back to the main menu.

The time and site information will be stored inside the HC memory chip. If you are not traveling to another observation site, they do not need to be changed.

3.2.7. STEP 7. Polar Alignment

CAUTION: It is recommended that whenever possible you perform this procedure before loading the OTA.

NOTE: You may need to re-check the polar alignment after loading the OTA.

As explained in the introduction, an equatorial mount must have an accurate polar axis alignment in order to track properly. With the iOptron innovative Polar Scope and Quick Polar Alignment procedure, you can do a fast and accurate polar axis alignment.

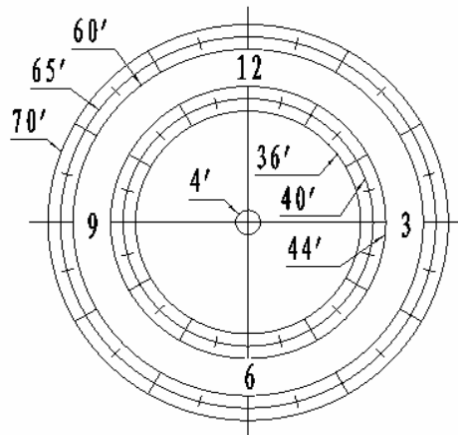

Figure 11. Polar Scope Dial

As indicated in Figure 11, the Polar Scope Dial has been divided into 12 hours along the angular direction with half-hour ticks. There are 2 groups, 6 concentric circles marked from 36' to 44' and 60' to 70', respectively. The 36' to 44' concentric circles are used for polar alignment in northern hemisphere using Polaris. While the 60' to 70' circles are used for polar alignment in southern hemisphere using Sigma Octantis.

You have already pointed the tripod to True North in 3.2.1 and set your current latitude in 3.2.3. Now, you are ready to perform the Quick Polar Axis Alignment procedure.

Polar axis adjustments

Whenever polar axis adjustments are required, loosen the three Azimuth Locking Screws and adjust the Azimuth Adjustment Knobs to do a fine adjustment of the mount in the azimuth direction. Tighten the locking screws to secure the mount. Loosen four Latitude Locking Screws on the side of the mount, turning the Latitude Adjustment Knob to adjust the latitude (altitude). Use the Lever for a fine latitude adjustment. Re-tighten the lock screws.

Initializing the polar scope

NOTE: Do not disassemble the Polar Scope to rotate it. It is adjusted at the factory and can be misaligned if you disassemble it. A good Polar alignment is the basis for good GOTO and tracking performance.

During initial setup of the iEQ mount, it is likely that the viewing hole on the DEC axis of the polar scope may be blocked by the DEC axle. The Polar Scope Dial in the polar scope may not be set at the normal clock position with 12 located at the top, as shown in Figure 11. Before doing the Quick Polar Axis Alignment, complete the following steps:

- (1) Take off both the Polar Axis Cover and the Polar Scope Cover from the mount.
- (2) First, thread the dark field illuminating LED end into the threaded hole located on the Polar Scope. Then plug the other end into the Reticule socket located on the R.A. unit. The illumination intensity can be adjusted using the hand controller (HC) via the “**Set Eyepiece Light**” function under the “**Set Up Controller**” menu.
- (3) Use the ▲ or ▼ button to turn the DEC axle to unblock the Polar Scope view.
- (4) Adjust polar scope eyepiece shown in Figure 12 to bring the polar scope dial in focus.
- (5) To rotate the Polar Scope to align the 12 position of the dial on the top, as shown in Figure 11, release the four R.A. clutch screws while holding the OTA, if an OTA is mounted. Then turn the R.A. drive using HC’s ◀ or ▶ button (press 9 button to change the rotation speed to MAX). If your Polar Scope is equipped with a bubble level indicator, as shown in Figure 12, simply make sure the bubble is in the middle.

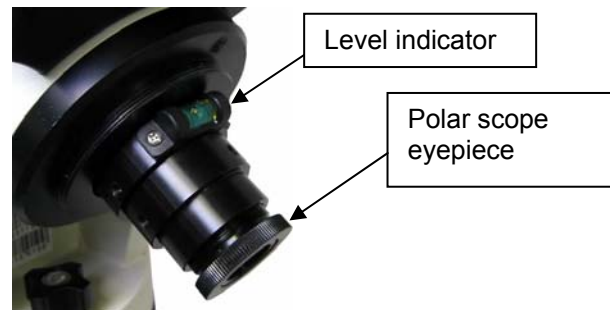

Figure 12. Polar scope with bubble level indicator

Quick Polar Alignment

- (1) Turn on the mount power by pressing the **On/Off** switch on the R.A. unit. Pressing the **MENU** button, then select “**Align**” and “**Pole Star Position**”. For example, on May 30, 2010, 20:00:00 in Boston, US (Lat N42°30’32” and Long W71°08’50”), 300 min behind UT, the Polaris Position is 1hr 26.8m and r= 41.5m, as shown in Figure 13 (a).
- (2) Look through the polar scope; make sure the polar scope is not blocked by the DEC axle. The 12 o’clock indicator of the Polar Scope Dial must be positioned on top.
- (3) Follow the **Polar axis adjustment** procedure (**not the hand controller**) to adjust the mount in altitude (latitude) and azimuth (heading) direction and place Polaris in the same position on the Polar Scope Dial as indicated on the HC LCD. In this case, the Polaris will be located at a radius of 41.5’ and an angle of 1 hour 26.8 minute, as shown in Figure 13 (b).

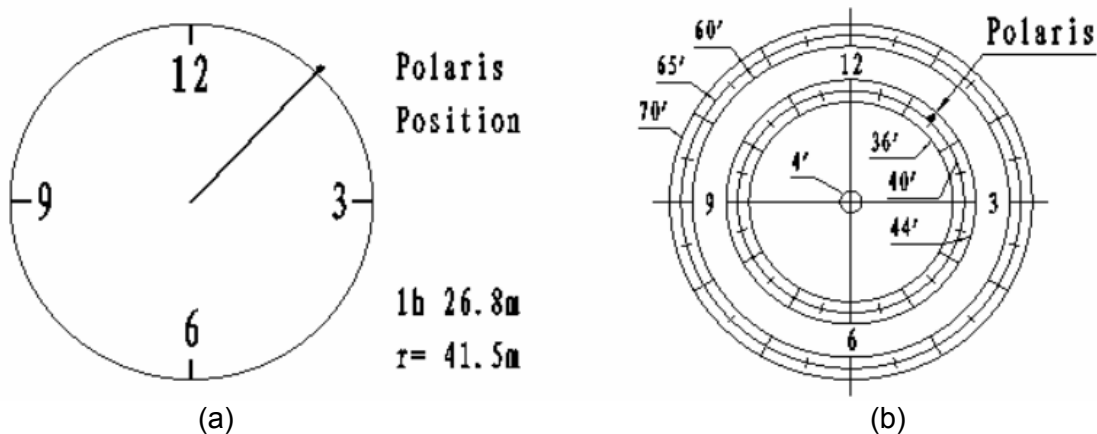

Figure 13

NOTE: Thread the polar scope eyepiece all the way in after polar alignment, before put the Polar Scope Cover back on. Otherwise, the polar scope eyepiece could be stuck inside the Polar Scope Cover to cause R.A. axis jamming.

NOTE: If you are located in southern hemisphere, Sigma Octantis will be chosen for Polar Alignment. For example, on May 20, 2010, 20:00:00 in Sydney, Australia (Lat S33°51'36" and Long E151°12'40"), 600 min ahead of UT, the Sigma Octantis Position is 1hr21.8m and 64.4m.

BrightStar Polar Alignment

For those who can't see the pole star, you can use BrightStar Polar Alignment procedure described in 5.4.1.

3.2.8. STEP 8. Install Counterweight(s)

iEQ45 comes with two 11lb (5kg) counterweights (CWs). Use one or both CWs as required for your particular OTA. Additional CW(s) or shaft extension bar may be needed to balance a heavier OTA.

Remove the CW Safety Screw on the end of the CW shaft. Loosen the CW Locking Screw on the side of the CW (there is a CW pin inside) and slide the CW into the shaft as shown in Figure 13(a). Tighten the CW Locking Screw to hold the CW in place. Tighten the CW Safety Screw.

CAUTION: For safety reasons, the CW Safety Screw must be installed and tightened to prevent the CW from dropping off the end of the CW shaft. This can cause serious personal injury.

Optional CW shaft extension, as shown in Figure 14(b) or extra counterweight(s) are available for purchase for those the payload (payload torque, more precisely) exceeds the equipped CWs.



Figure 14

3.2.9. STEP 9. Attach and Balance an OTA on the Mount

After attaching an OTA and accessories to the mount, the mount must be balanced to ensure minimum stress on the mount's gears and motors. There are four (4) Clutch Screws on R.A. axis and one Clutch Handle on DEC axis. Each axis will rotate freely after the related clutch screws are released. The balancing procedure should be performed after the CWs, OTA, and any accessories are installed.

CAUTION: The telescope may swing when the R.A. and DEC clutch screws or handle are released. Always hold on to the OTA before you release the clutch screws or handle to prevent it from swinging. It can cause personal injury or damage to the equipment.

Balance the mount in DEC axis

Release the four (4) R.A. Clutch Screws and rotate the R.A. axis to place the DEC axis in the horizontal position, as shown in Figure 15(a), and then tighten the R. A. Clutch Screws. The OTA can be on either side. Then release the DEC Clutch Handle and rotate the OTA to a horizontal position as shown in Figure 15(b). If the OTA has a tendency to rotate about the DEC axis, you will have to slide the OTA forward or backward to balance it in the horizontal position about the DEC axis. When the OTA is balanced horizontally, tighten the DEC Handle.

Balance the mount in R.A. axis

Release the four (4) R.A. Clutch Screws. If the DEC axis stays in the horizontal position, as shown in Figure 15(a), it means the R.A. axis is balanced. Otherwise, release the CW Locking Screw and move the CW as required to balance the R.A. axis. Tighten the CW Locking Screw.



Figure 15

Adjust the mount to Zero Position

After polar alignment, adjust the mount at Zero Position. The Zero Position is the position with the CW shaft pointing toward the ground, OTA at the highest position with its axis parallel to the polar axis and the OTA pointing to the NCP, as shown in Figure 16. Loosen the DEC Clutch Handle on the DEC axis and the four (4) R.A. Clutch Screws on the R.A. axis to adjust the mount to the Zero Position. Tighten the screws after each adjustment. **Remember, the hand controller needs to be at the Zero Position as well!** The simplest way is turn the mount power OFF and ON again to reset the hand controller.



Figure 16. Zero position

You can also use the electronic Balance Test function to check the R.A. and DEC balance (please refer to Section 5.12 for more details).

4. Getting Started

In order to experience the full GOTO capability of GOTO NOVA technology it is very important to set up the mount correctly before observation.

4.1. Setup the Mount and Polar Alignment

Assemble your iEQ45 mount and do a polar alignment, if needed, according to Section 3.2. Mount an OTA and accessories, and carefully balance it in both R.A. and DEC axes. The default position for the mount is the Zero Position, as shown in Figure 16, when the mount is powered on: the counterweight shaft is pointing to ground, telescope is at the highest position with its axis parallel to the polar axis and the telescope is pointing to the North Celestial Pole, if you are located in northern hemisphere.

4.2. Manual Operation of the Mount

You may observe astronomical objects using the arrow keys of a Go2Nova[®] hand controller.

Flip the I/O switch on the telescope mount to turn on the mount. Use ►, ◀, ▼ or ▲ buttons to point the telescope to the desired object. Use the number keys to change the slewing speed. Then press **STOP/O** button to start tracking.

4.3. Initial Star Alignment

A simple star alignment/synchronization can be performed to improve the GOTO accuracy.

To perform “**One Star Align**,” press MENU button, scroll down to “**Align**”, select “**One Star Align**” and press ENTER. The screen will display a list of bright objects for you to select from. Select an object using ▲ or ▼ key. Then press ENTER. After the mount slews to the target, use the arrow keys to center it in your eyepiece. Then press ENTER.

An alternate way is to perform “**Sync to Target**.” Press the MENU button, select “**Select and Slew**” and press ENTER. Browse over the catalogs and select an object, such as “**Stars**” → “**Named stars**”, and press ENTER. After the mount slews to the star, press the MENU button, scroll down to “**Sync. To Target**”, follow the on-screen instruction to center Polaris and press ENTER. You may use the number key to change the slewing speed to make the centering procedure easier.

4.4. Go to the Moon and Other Stars

After performing these set-ups the mount is ready to GOTO and track objects. One of the most common objects is the Moon.

To slew to the Moon press the MENU button. Select “**Select and Slew**” by pressing the ENTER button. Select “**Solar System**”, and use the ▲ or ▼ buttons to select Moon. Press ENTER. The telescope will automatically slew to the Moon and lock on it. It will automatically begin to track once it locks on. If the Moon is not centered in your eyepiece, use the arrow keys to center the Moon. Or for better performance use “**Sync to Target**.”

You may also select other bright celestial objects to start with, such as Jupiter or Saturn.

4.5. Star Identifying Function

The 8407 hand controller has a star identifying function. After **Set Up Time and Site**, slew the telescope to an bright star, manually or using GOTO. Press ? (Help) button to identify the star name telescope is pointing to, as well as nearby bright stars if there are any.

4.6. Turn Off the Mount

When you have finished your observation, just simply turn the mount power off and disassemble the mount and tripod. If the mount is set up on a pier or inside an observatory, it is recommended that you return the mount to Zero Position, or Park Position before powering down. This will ensure that there is no need for you to perform the initial setup again when you power up the mount subsequently, if the mount is not moved. To return the mount to its Zero Position, press the MENU button, scroll down to “**To Zero Position**” and press ENTER. Once the telescope returns to Zero Position turn the power off.

5. Complete Functions of Go2Nova[®] Hand Controller

5.1. Slew to an Object

Press the MENU button. From the main menu select “**Select and Slew.**” Select an object that you would like to observe and press the ENTER key.

The Go2Nova[®] 8407 hand controller has a database of about 358,000 objects. Use the ► or ◀ buttons to move the cursor. Use the number buttons to enter the number, or the ▼ or ▲ buttons to change the individual number. Hold on a button to fast scroll through the list. The “☉” indicates the object is above the horizon, and a cross mark “☽” means it is below the horizon. In some catalogs those stars below the horizon will not display on the hand controller.

5.1.1. Solar System

There are 9 objects in the Solar system catalog.

5.1.2. Deep Sky Objects

This menu includes objects outside our Solar system such as galaxies, star clusters, quasars, and nebulae.

- Named Objects: consists of 60 deep sky objects with their common names. A list of named deep sky objects is included in Appendix E.
- Messier Catalog: consists of all 110 Messier objects.
- NGC IC Catalog: consists of 7,840 objects in NGC catalog and 5,386 objects in IC catalog. To select an object from NGC or IC catalog, move the cursor to NGC, using ▲ or ▼ button to toggle between NGC and IC. Then move the cursor to a numerical position and use the number button to select the object.
- UGC Catalog: consists of 12,921 objects.
- MCG Catalog: consists of 30,642 objects.
- Caldwell Catalog: consists of 109 objects.
- Abell Catalog: consists of 4,076 objects.
- Herschel Catalog: consists of 400 objects.

5.1.3. Stars:

- Named Stars: consists of 195 stars with their common names. They are listed alphabetically. A list is included in Appendix E.
- Binary Stars: consists of 210 binary stars. A list is attached in Appendix E.
- GCVS Variable Stars: consists of 38,528 GCVS variable stars. They are listed numerically.
- SAO Catalog: consists of 258,997 SAO catalog objects. They are listed numerically.

5.1.4. Constellations

This catalog consists of 88 modern constellations with their names. They are listed alphabetically. A list is attached in Appendix E.

5.1.5. Comets

This catalog contains 15 comets.

5.1.6. Asteroids

This catalog contains 116 asteroids.

5.1.7. User Objects

It can store up to 60 used entered objects.

5.1.8. Enter R.A. DEC

Here you can go to a target by entering its R.A. and DEC numbers.

5.2. Sync to Target

This operation will match the telescope's current coordinates to Target Right Ascension and Declination. After slewing to an object, press MENU—then scroll to “**Sync to Target**” and press ENTER. Follow the screen to do the sync. Using this function will re-calibrate the computer to the selected object. Multiple syncs can be performed if needed. This operation is most useful to find a faint star or nebula near a bright star.

“**Sync to Target**” will only work after “**Select and Slew**” is performed. You can change the slewing speed to make the centering procedure easier. Simply press a number (1 through 9) to change the speed. The default slew speed is 64X.

“**Sync to Target**” does the same thing as one star alignment except that you choose the object to “sync” to. “**One star align**” chooses the star/object for you.

5.3. Set Up Controller

5.3.1. Set Up Time & Site

Refer to 3.2.6.

5.3.2. Set Display and Beep

Press MENU button, from the main menu, scroll down and select “**Set Up Controller**”. Press ENTER and select “**Set Display and Beep**”:

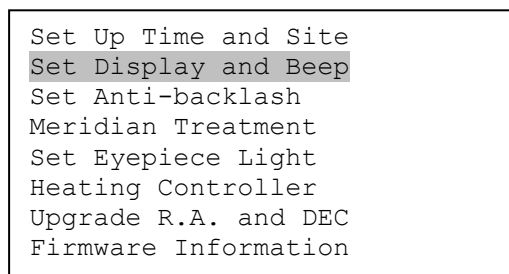

Use arrow keys to adjust LCD display contrast, LCD backlight intensity, keypads backlight Intensity and turn the keep beep ON/OFF

5.3.3. Set Anti-backlash

All mechanical gears have a certain amount of backlash or play between the gears. This play is evident by how long it takes for a star to move in the eyepiece when the hand control arrow buttons are pressed (especially when changing directions). The Go2Nova anti-backlash feature allows user to

compensate for backlash by inputting a value which quickly rewinds the motors just enough to eliminate the play between gears.

To set the anti-backlash value, scroll down and select “Set Anti-backlash”

```
Set Up Time and Site
Set Display and Beep
Set Anti-backlash
Meridian Treatment
Set Eyepiece Light
Heating Controller
Upgrade R.A. and DEC
Firmware Information
```

Press ENTER. A R.A. anti-backlash screen will display:

```
R.A. anti-backlash:
      0000 steps
One step equals to
0.09 arc second.
```

To adjust steps move the cursor to each digit and use the number keys to input number directly. Press ENTER – “DEC anti-backlash” will display:

```
DEC anti-backlash:
      0000 steps
One step equals to
0.10 arc second.
```

Move the cursor to each digit and use the number keys to set the anti-backlash. Press ENTER to go back the previous screen. Press BACK button to go back to main menu.

While viewing an object in the eyepiece, observe the responsiveness of each of the four arrow buttons. Note which directions you see a pause in the star movement after the button has been pressed. Working one axis at a time, adjust the backlash settings high enough to cause immediate movement without resulting in a pronounced jump when pressing or releasing the button. The hand controller will remember these values and use them each time it is turned on until they are changed.

The 8407 hand controller has a function to test the mount backlash number and can store the anti-backlash steps here. The maximum steps are 9999.

5.3.4. Meridian Treatment

This function tells mount what to do when it tracks across the meridian. There are three options. Stop Tracking will stop the mount when it passes the meridian. Telescope Flip will flip the telescope and continuous to track the object. The third option is Continue to Track. In this case, the mount will keep tracking and the OTA could hit the tripod leg if the mount is not monitored.

5.3.5. Set Eyepiece Light

Use this function to adjust the light intensity of iEQ45 illuminated polar scope. If you have an illuminated-reticule eyepiece and it is supported by Go2Nova hand controller, use this option to adjust its light intensity.

5.3.6. Heating Controller

Turn on/off the controller internal heater.

5.3.7. Upgrade RA & DEC

Use this operation to upgrade 8407 hand controller R.A. and DEC motor controller firmware. It only needed under a very rare circumstance. Please refer to iOptron online announcement when the event happens.

Please refer to iOptron online documents for iEQ45 main control board and 8407 hand controller firmware upgrade details.

5.3.8. Firmware Information

This option will display firmware version information of hand controller, main board, R.A. control board and DEC control board.

5.4. Align

This function is used for aligning the telescope. There are three star alignment methods: “SolarSys Align”, “One Star Align” and “Two Star Align”. The mount has to be at Zero Position before performing any star alignment.

The Polar Align function, BrightStar Polar Alignment, uses two bright stars to perform the polar axis alignment for those who can't see the Pole Star, Polaris or Sigma Octantis, from the observation location.

Pole Star Position function will display current pole star coordinates that used for Quick Polar Alignment.

5.4.1. Polar Alignment

Press the MENU button, then select “**Align**” and “**Polar Align**”. The HC will display the azimuth and altitude position of several bright stars near meridian. Select one that is visible with high altitude as Alignment Star A. Follow the HC instruction to move the Star A to the center of the eyepiece with the combination of Latitude Adjustment Knob and “◀” or “▶” button. Press ENTER to confirm. Next, select a bright star that is close to the horizon as the Alignment Star B. Center it using the Azimuth Adjustment Knob and “◀” or “▶” button (*The “▲” and “▼” buttons are not used here*). Press ENTER to confirm.

The telescope will now slew back to Star A to repeat above steps. The iteration can be stopped when it is determined that the alignment error is at the minimum. Press BACK button to exit alignment procedure.

NOTE: It is highly recommended to use an eyepiece with crossed-hair line for accurate centering.

NOTE: The movement of the alignment star in your eyepiece may not be perpendicular but crossed, depends on its location in the sky.

5.4.2. SolarSys Alignment

This function uses planets or moon as the alignment star. Press MENU button and select “**Align**”. Select “**SolarSys Align**” and press ENTER. With the mount at the “Zero Position,” use ▲ and ▼ buttons to select an object and press ENTER. After mount slew to the object, center the target in your eyepiece using arrow key. Press ENTER when finished.

5.4.3. One-Star Alignment

Press MENU button and select “**Align**”. Select “**One Star Align**” and press ENTER. A list of alignment stars that are above the horizon is computed based on your local time and location. With the

mount at the “Zero Position,” use ▲ and ▼ buttons to select a star and press ENTER. Center the target in your eyepiece using arrow key. Press ENTER when finished. If your mount is well set up and polar aligned, one star alignment should be sufficient for good GOTO accuracy. To increase the accuracy you may choose to do two star alignment.

5.4.4. Multi-Star Alignment

With iOptron’s multi-star alignment, you can choose two, three, or as many stars as you want to reduce the mount alignment offset.

Press MENU button and select “**Align**”. Select “**Multi-Star Align**” in the align menu. A list of alignment stars that are above the horizon is computed based on your local time and location. With the mount is at the “Zero Position,” use ▲ and ▼ buttons to select first alignment star and press ENTER. Center the target in your eyepiece using arrow key. Press ENTER when finished. The hand controller will prompt you to choose the second star. If the star you choose is too close to the first one, the system will let you choose another one. When you are aligned with the second star, the two star alignment is finished. You can reject the suggested star if it is blocked by a tree or other obstruction.

If you’ve done with the two star alignment, press the BACK button to finish the alignment. Press ENTER key to select third star for further alignment.

5.4.5. Test Backlash

This function is used to test the R.A. and DEC backlash value. The saved numbers will show in “**Set Anti-backlash**” menu. To get better results, perform this function on a land object during daytime and use a cross-hair eyepiece.

Lower the mount altitude to its lowest position. Release the R.A. clutch to move the telescope to east or west side of the mount. Tighten the R.A. Clutch Screws. Release DEC clutch and put the telescope in horizontal position.

To test the backlash, point the telescope to a tip of a distant object, such as a telephone pole. Select “**Test Backlash**” under “**Align**” menu and press ENTER:

```
R.A. axis test

Press "▶" or "◀" to
target then press
"ENTER"
```

Using “▶” or “◀” to move the object to center, press the ENTER button. Do not move over the center. You may use a slow speed when the object is close to the center. The LCD screen will change to

```
R.A. axis test

Press "▶" return to
target then press
"ENTER"
```

Follow the on-screen instruction to bring the object back to center again and press ENTER. The screen will show

```
R.A. anti-backlash  
  
0250 steps  
  
Save test value?
```

If you want to save this anti-backlash number, press ENTER. Otherwise press BACK. This will bring the hand controller to DEC backlash testing screen. Follow the on-screen instruction to test the DEC backlash.

5.4.6. Pole Star Position

This shows Polaris position in northern hemisphere or Sigma Octantis position in southern hemisphere, which is used for Quick Polar Alignment.

5.5. PEC Option

5.5.1. PEC Playback

You can turn “**PEC Playback On**” while you do the tracking, especially for long time astrophotography. A “PEC” indicator will displayed on the LCD main screen when it is turned on. The default status is PEC Playback Off when the mount is turned on.

5.5.2. Record PEC

All Equatorial mounts have a small variation in the worm gears which can be corrected by using Period Error Correction or PEC. PEC is a system which improves the tracking accuracy of the mount by compensating for variations in the worm gear and is especially useful when doing astrophotography without autoguiding. Because the variations are regular, it is possible to record the corrections required to cancel out the worm gear variations and to play them back.

In order to use the PEC function, the Go2Nova hand controller needs to record the PE first. The periodic error of the worm gear drive will be stored and used to correct periodic error. There is no need to record the PE value again unless it is necessary, such as wearing of worm gear after extended use.

Here’s how to use the PEC function.

1. Setup the mount with a telescope in autoguiding condition by connecting a guiding camera to a computer via ST-4 autoguiding port or ASCOM protocol;
2. Press MENU, select “**Auto Guide**” and press ENTER. Select a guiding speed from 0.20X to 1.00X;
3. Then press the BACK button and select “**PEC Option**” from the menu. Use the ▲ and ▼ scroll buttons to display the “**Record PEC**” option and press ENTER to start record the PE.
4. It takes the worm gear 400 seconds to make one complete revolution. After 400 seconds PEC will automatically stop recording. The PEC value will permanently stored inside PEC chip on R.A. motor drive until a new data are recorded.
5. If you want to re-record the periodic error, select “**Record PEC**” and repeat the recording processes again. The previously recorded information will be replaced with the current information.

5.5.3. System Self-Test

If system self-test function is turned on, the mount will swing back and forth about 2 seconds to check the PEC encoder condition.

5.6. Set Tracking Rate

You can set up tracking in the main menu by selecting “**Set Tracking Rate**”. Then the user can select “**Sidereal speed**”, “**Solar speed**”, “**Lunar speed**”, “**King speed**” and “**User defined speed**”. For “User defined speed,” it can be adjusted from 0.9900X to 1.0100X of sidereal speed by pressing the ▲ or ▼ button or number buttons.

5.7. Set User Objects

Besides various star lists available in the hand controller --you can add, edit or delete your own user-defined objects. You can also add your favorite observation object into the user object list for easy sky surfing. Up to 60 user objects can be stored here.

You also can enter new comets by select “**Set the Comet**” submenu.

To set user objects, press MENU button, from the main menu, scroll down and select “**Set User Objects**”.

```
Select and Slew
Sync. to Target
Electric Focuser
Set Up Controller
Align
PEC Option
Set Tracking Rate
Set User Objects
```

Press ENTER to bring up user objects setting screen. Then select “**Objects Except Comet**” submenu:

```
Add a New Record
Browse Records
Delete One Record
Delete All Records
```

Select “**Add a New Record**” from Objects Except Comet screen. A screen will display asking to **Enter R.A. DEC**:

```
Enter R.A. DEC

R.A.:  00h00m00s
DEC:  +00d00m00s
```

You may enter the R.A. and DEC coordinates of the star you want to watch, and press **ENTER**. A confirmation screen will show. Press **ENTER** to confirm storing your object under assigned user object number, or press **BACK** button to cancel it.

A more convenient way to enter your viewing objects is direct from the star catalogs. When “**Enter R.A. DEC**” screen showed, press the **MENU** button. It brings up the star catalogs that you can select the star from. Follow the screen to add your favorite objects. Press **BACK** button to go back one level.

Press **BACK** button few times to go back to “**Set User Objects**”. You may review the records or delete the ones you don’t want it anymore. Press **BACK** button to finish the operation. Now you can slew to your favorite stars from “**User Objects**” catalog using “**Select and Slew.**”

To enter a new comet data, select “Set the Comet” submenu and press **ENTER**:

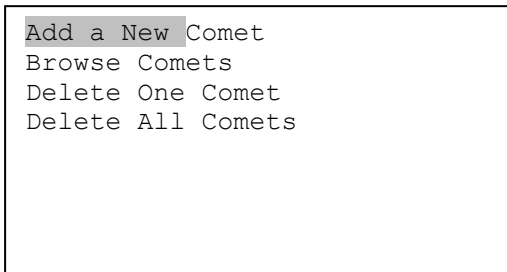

Select “**Add a New Record**” from the screen. A screen will ask to **Enter Comet Parameter**:

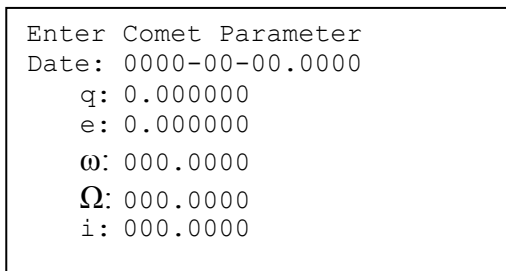

Enter the comet data in the format of **date** (YYYY-MM-DD.HHHH), **q**, **e**, **ω**, **Ω**, and **i**.

5.8. Guide Options

5.8.1. Set Guider Rate

This is an advanced function for autoguiding when a guiding camera is equipped either via an ST-4 guiding port or an ASCOM protocol. Before autoguiding, align the polar axis carefully. Select a proper guiding speed. The suppositional guiding speed can be selected from ±0.20X to ±1.00X. Follow the autoguiding software for detailed operation.

5.8.2. Guide Port Direction

The Guide Port iEQ45 equipped is capable to handle an ST-4 autoguiding camera with both straight and a reverse wired RJ11 guiding cable. Select “**Reverse**” option in the “**Auto Guide**” function for an ST-4 camera with a reversed RJ11 guiding cable, as shown in Figure 17.

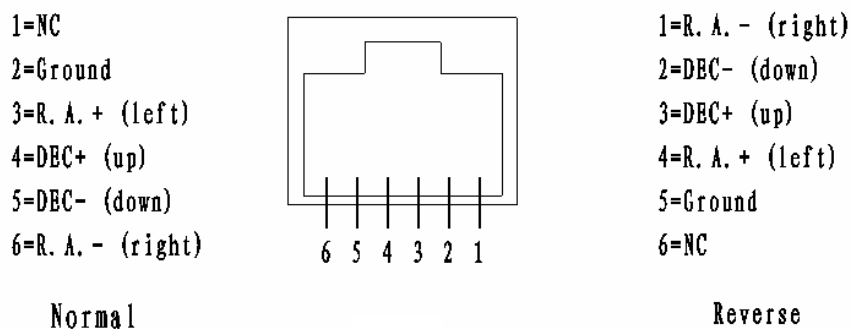

Figure 17. ST-4 guiding port wiring direction

5.9. Set Slewing Rate

You can select the maximum GOTO speed to be 128X, 256X, 512X, or MAX. The slower the speed, the quieter the motors run.

5.10. Park Scope

There are two parking positions: east side or west side. The mount may move to either position depends on which one is closer, when "**Park Scope**" is selected. The mount will remember the Zero Position if the power is turned off after "**Park Scope**".

5.11. To Zero Position

This moves your telescope to its Zero Position (refer to Figure 16). When the power is turned on, the mount assumes the Zero Position. This is its reference point for all other objects being tracked.

5.12. Balance Test

This function provides a visual indication and assistance balancing both the R.A. and DEC axes. Before performing the balance test, make sure the correct latitude is set according to the instructions in Section 2.5, Step 4. Turn the mount on and make sure the telescope is in the Zero Position.

Press the **MENU** button, scroll down to "**Balance Test**", and press **ENTER**. The mount will start to slew and stop at the balance position. You can select either "**DEC Balance Test**" or "**RA. Balance Test**."

Select "**RA Balance Test**" and press **ENTER** to start the test. After few swings, a test results will be displayed on the hand controller LCD screen (Figure 18 (a)):

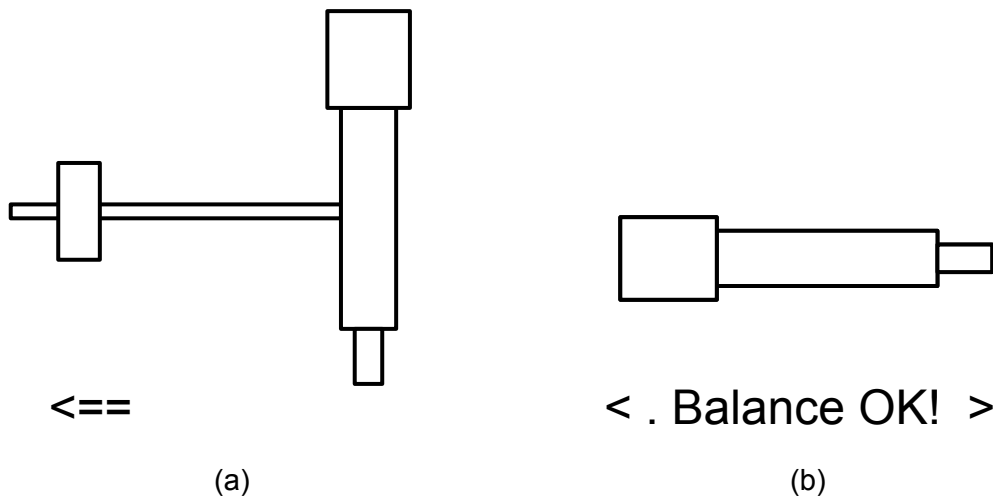

Figure 18. (a) R.A. and (b) DEC Balance Test

Follow the arrow indicator to move the CW left or right. There are six balance test indicators in each direction:

< **Balance OK!** >: The R.A. is balanced;

< . **Balance OK!** > or < **Balance OK!** . >: The R.A. is almost balanced; a minor adjustment may be done;

< .. **Balance OK!** > or < **Balance OK!** .. >: The mount balance is OK for observation; a small adjustment may be done;

<= or =>: Move counterweight left or right;

<== or ==>: Move counterweight left or right more;

<=== or ===>: The R.A. axis is off balance. Move counterweight according to the arrow left or right.

Press the **ENTER** key to test it again, until the **< Balance OK!>** indicator is displayed.

Press **BACK** button and select "DEC Balance Test". Move the telescope back and forth to balance the OTA around the DEC axis until **< Balance OK! >** is displayed.

6. Maintenance and Servicing

6.1. Maintenance

The iEQ45 is designed to be maintenance free. Do not overload the mount. Do not drop the mount, this will damage the mount or degrade the GOTO tracking accuracy permanently. Use a wet cloth to clean the mount and hand controller. Do not use solvent.

If your mount is not to be used for an extended period, dismount the OTAs and counterweight(s).

6.2. iOptron Customer Service

If you have any question concerning your iEQ45 contact iOptron Customer Service Department. Customer Service hours are 9:00 AM to 5:00 PM, Eastern Time, Monday through Friday. In the unlikely event that the iEQ45 requires factory servicing or repairing, write or call iOptron Customer Service Department first to receive an RMA# before returning the mount to the factory. Please provide details as to the nature of the problem as well as your name, address, e-mail address, purchase info and daytime telephone number. We have found that most problems can be resolved by e-mails or telephone calls. So please contact iOptron first to avoid returning the mount for repair.

It is strongly suggested that to send technical questions to support@ioptron.com. Call in the U.S. 1.781.569.0200.

6.3. Product End of Life Disposal Instructions



This electronic product is subject to disposal and recycling regulations that vary by country and region. It is your responsibility to recycle your electronic equipment per your local environmental laws and regulations to ensure that it will be recycled in a manner that protects human health and the environment. To find out where you can drop off your waste equipment for recycling, please contact your local waste recycle/disposal service or the product representative.

6.4. Battery Replacement and Disposal Instructions



Battery Disposal- Batteries contain chemicals that, if released, may affect the environment and human health. Batteries should be collected separately for recycling, and recycled at a local hazardous material disposal location adhering to your country and local government regulations. To find out where you can drop off your waste battery for recycling, please contact your local waste disposal service or the product representative.

Appendix A. Technical Specifications

Mount	German Equatorial Mount
Payload	45 lb (20kg)
Mount weight	20 lb (11.4kg)
Payload/Mount weight	1.75
Right Ascension worm wheel	Φ130mm, 216 teeth aluminum
Declination worm wheel	Φ115mm, 192 teeth aluminum
Right Ascension axis shaft	Φ50mm steel
Declination axis shaft	Φ40mm steel
Right Ascension bearing	Φ80mm angular contact bearing
Declination bearing	Φ68mm angular contact bearing
Worm gears	Brass
Motor drive	Planetary Gear Reducer DC servo with encoder
Resolution	0.09 arc seconds
Transmission	Synchronous belt/Gear
Latitude adjustment range	5° ~ 70°
Azimuth adjustment range	± 6°
GPS	Internal 32-channel GPS
Polar Scope	Yes. (with dark field illumination)
Level indicator	Precision bubble
Hand Controller	Go2Nova® 8407 with 358,000 objects database
PEC	Permanent PEC
Tracking	Automatic
Speed	1×,2×,8×,16×,64×,128×,256×,512×,MAX(~4°/sec)
Counterweight bar	Φ28mm
Counterweight	11 lb (5kg) X 2 (included)
Tripod	2" Stainless Steel (16.5lb or 7.5kg)
Dovetail	6" VIXEN/LOSMANDY-D dual saddle
Power consumption	0.25A(Tracking), 1.2A(GOTO)
Power requirement	12V DC(11 ~ 15V), 2Amp
AC adapter	100V ~ 240V (included)
Serial port	Yes (on hand controller)
RS232 port	Yes (on mount)
Autoguide port	Yes
Firmware upgrade	Yes
PC computer control	Yes (ASCOT)
Operation temperature	-20°C ~ 40°C

Appendix B. Go2Nova® 8407 HC MENU STRUCTURE

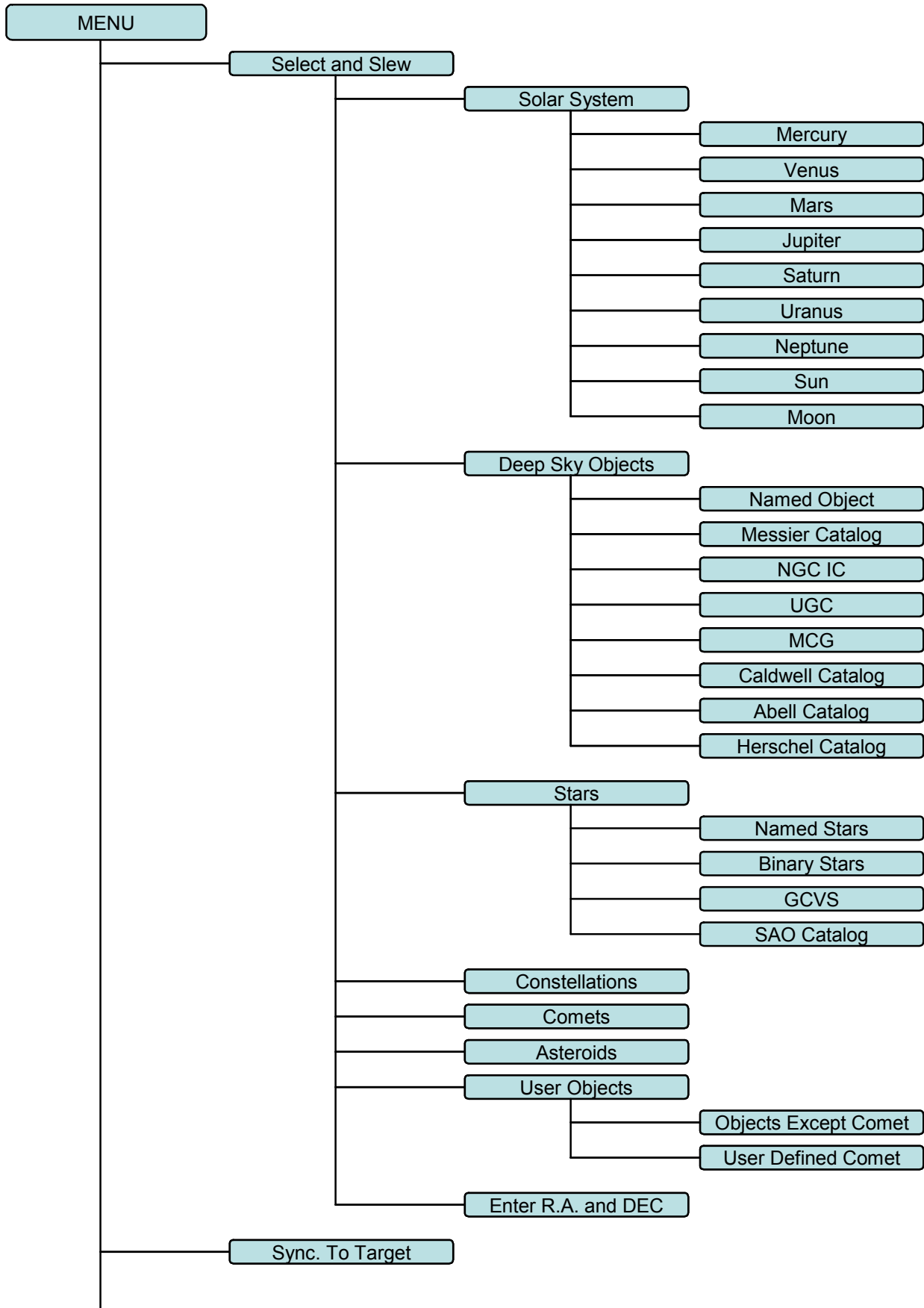

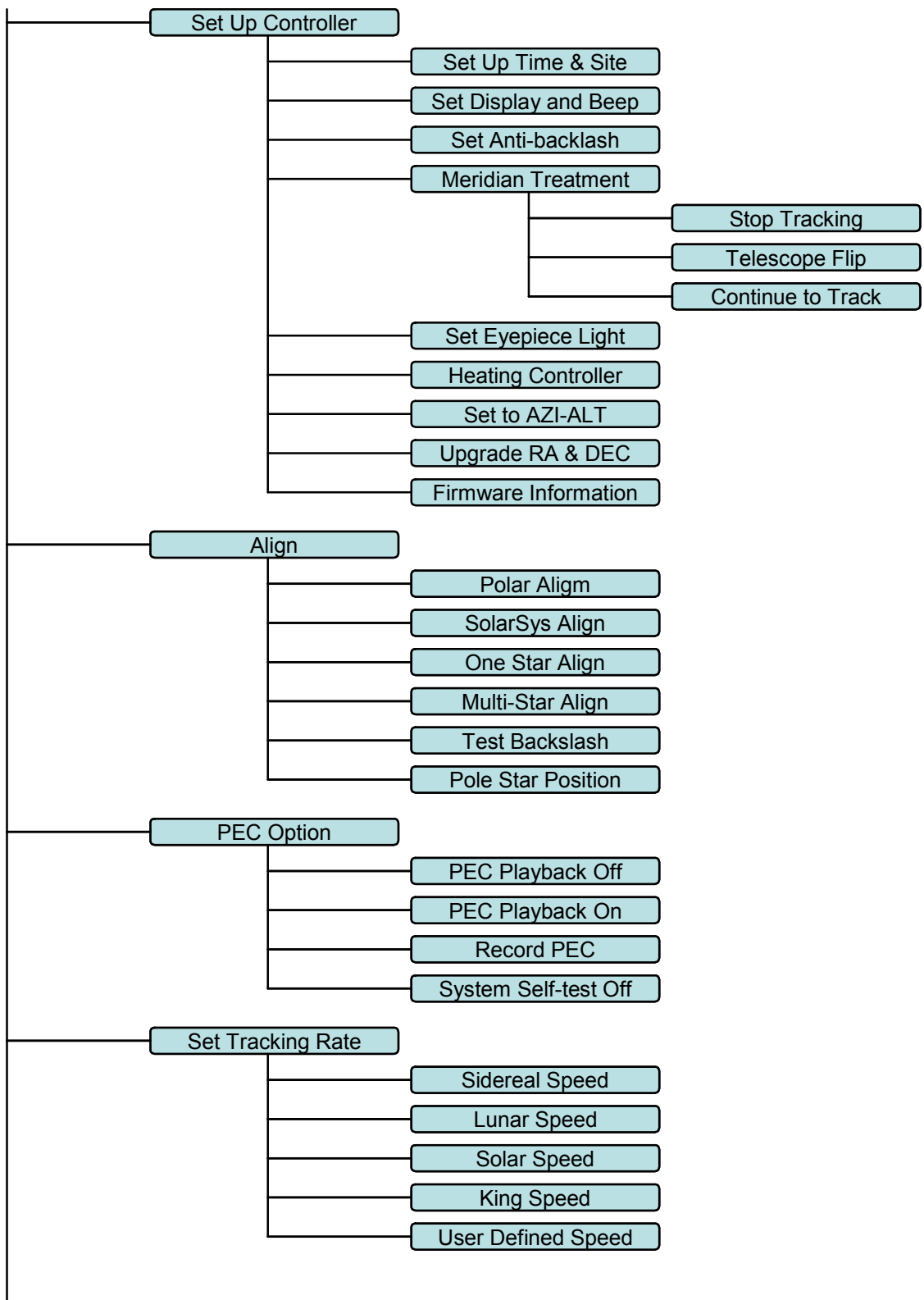

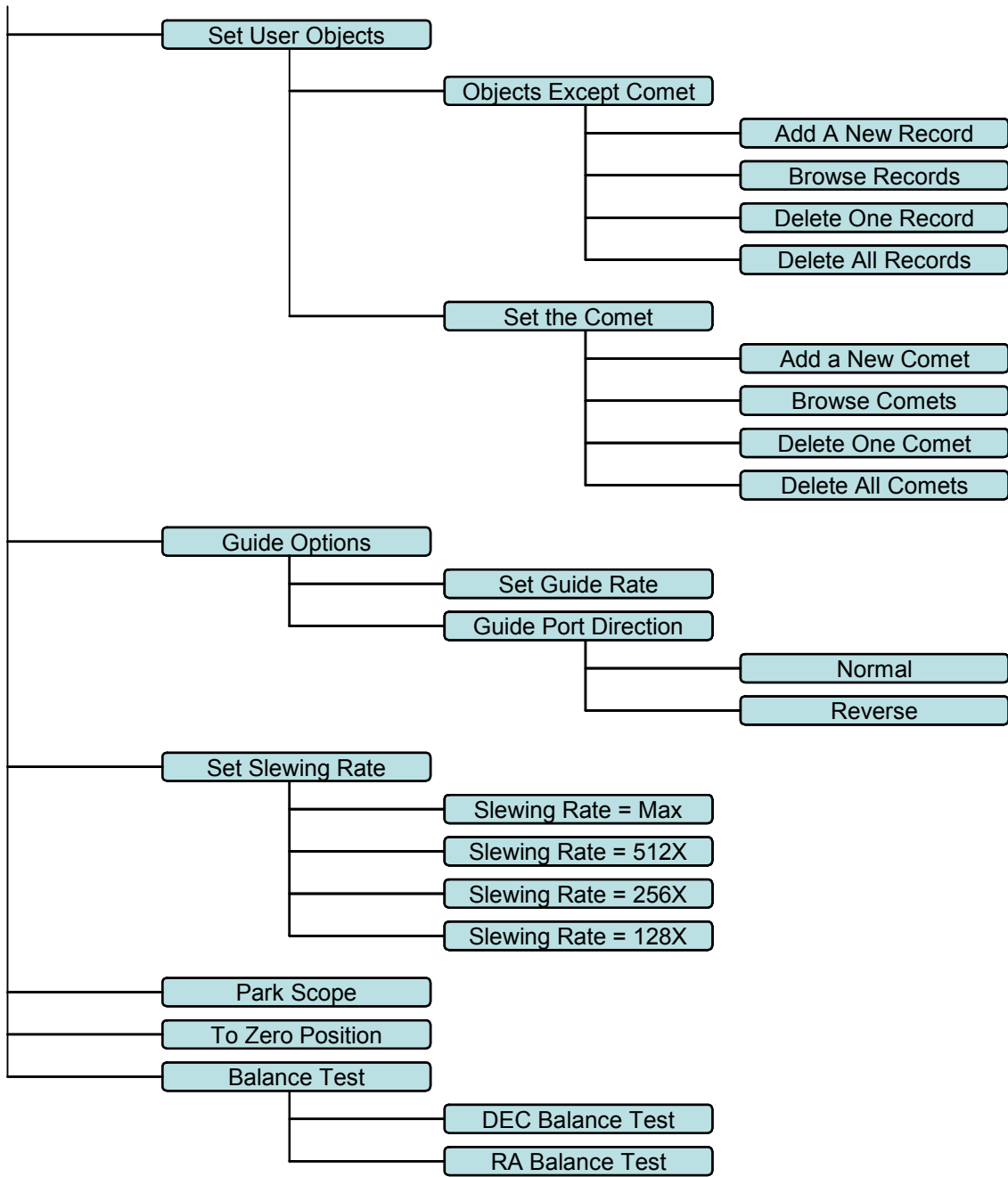

Appendix C. Firmware Upgrade

The firmware of an 8407 hand controller, as well as the main control board, R.A. and DEC motor control boards can be upgraded by the customer. Please check iOptron's website, www.iOptron.com, under Support Directory, for the most up to date firmware.

To upgrade the firmware, you need some or all of the following software/hardware, depends on the upgrading you are performing:

- iOptron Upgrade Utility Program
- 8407 hand controller firmware
- iEQ45 main board firmware
- iEQ45 R.A. board firmware
- iEQ45 DEC board firmware
- RJ9 serial port to RS232 cable (included, for hand controller upgrade)
- RS232 cable (included, for control boards upgrade)
- USB to RS232 converter and driver. If your computer does not equip a RS232 port (9-pin D-shape connector) except the USB port, you need to buy a USB to RS232 converter, form a computer hardware store or on-line.

1. Find the serial port (COM port) number from your computer:

In order to perform the firmware upgrade (as well as to use planetarium software to control the mount), the communication between the PC and hand controller or mount has to be established.

The first step is to find the COM port number. If your computer has a serial port (9-pin D-shape male connector on the back, next to the 25 pin printer connector), the default assigned number is COM1.

If your computer only has USB ports, like most laptops do, you need a USB to COM converter to convert one USB port to a COM port. Here are two examples of USB2COM converters.



After install the USB2COM driver that comes with the device, click on **Start** located on the left bottom corner of your compute screen. Move the mouse to **My Computer** and right click on it. Move the mouse down and click on **Properties**.

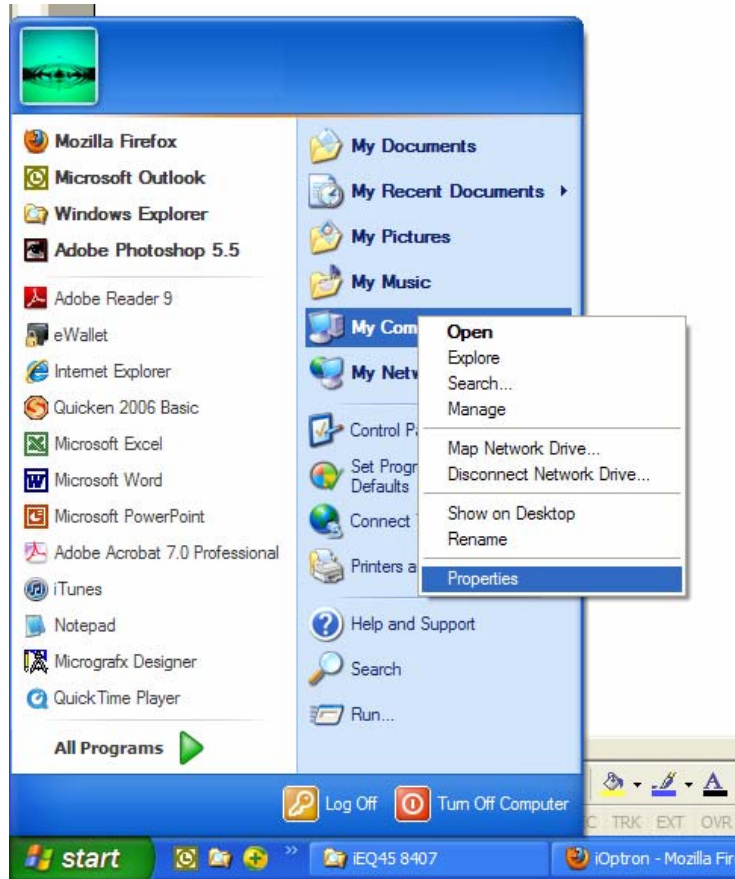

Click on **Hardware** and select **Device Manager**.

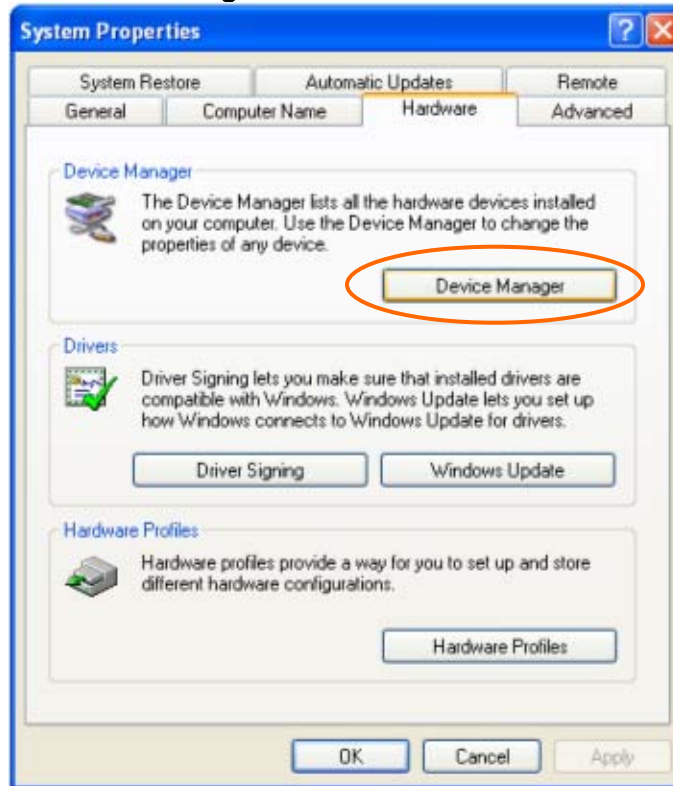

Double click on **Ports(COM & LPT)**, find out the COM number and write it down (in the following figure, the USB2COM converter uses a Prolific chipset and the assigned port number is COM1)

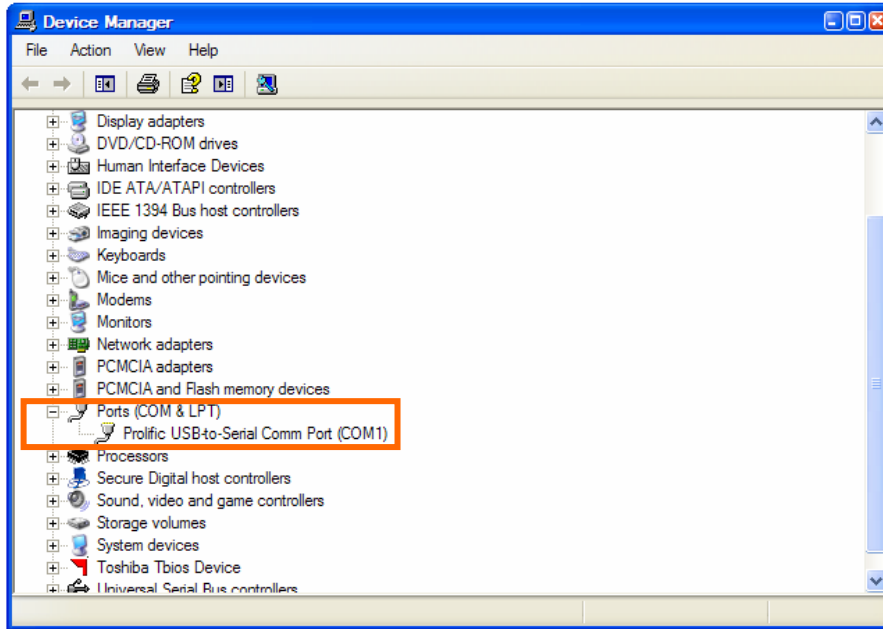

2. Download software and firmware from iOptron website:

Go to iOptron website, www.iOptron.com, click on **Download** tab. Locate **iEQ45 with 8407 hand controller** under **Software/Firmware Upgrades** catalog on the left part of the screen, and click on it.

Download and save Upgrade Utility software, 8407 and/or iEQ45 board software as needed.

3. Upgrade 8407 hand controller firmware:

- (1) Connect 8407 hand controller to the HBX port of an iEQ45 mount. Make sure the mount power is OFF;
- (2) Connect RJ9 plug into the serial port of a 8407 hand controller and the 9-pin RS232 connector to your computer's RS232 port (or RS232 port of the USB2COM converter);
- (3) Hold **ENTER** button of the hand controller while switch the ON/OFF button to turn the mount power on;
- (4) Locate download software and click on **Upgrade Utility.exe**:

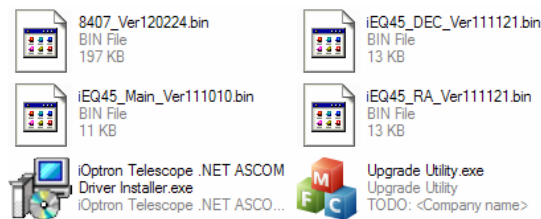

- (5) An iOptron Upgrade Utility window will display. Click on **Browse**:

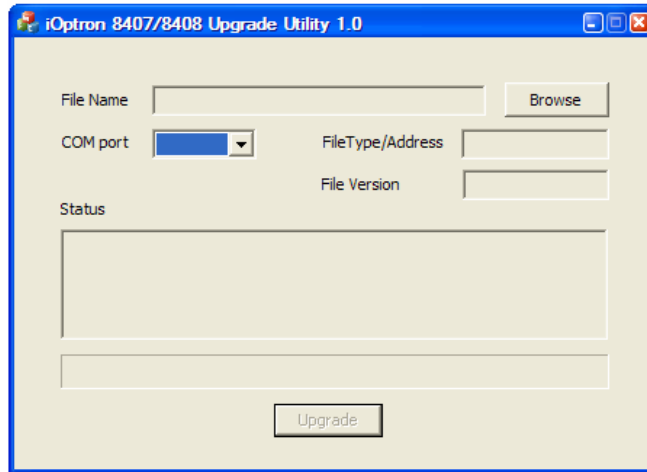

(6) Select hand controller firmware 8407_VerXXXXXX and click **Open**

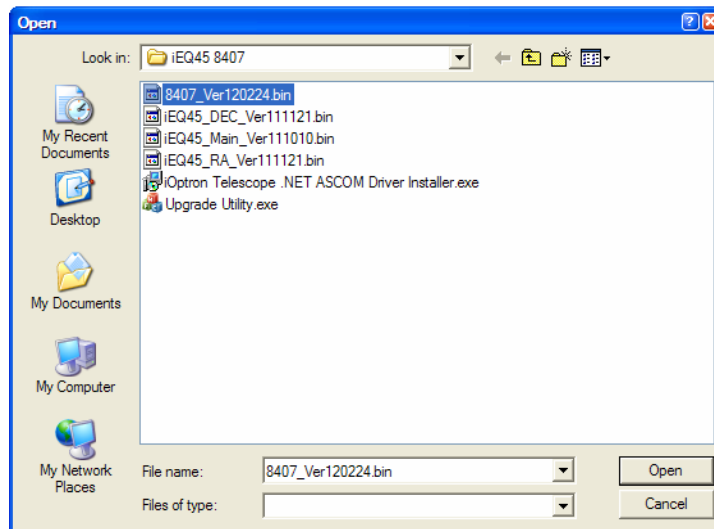

(7) The **FileType** and **Version** will be verified and displayed. Click on pull down menu of the COM port and select the COM port number. Here is **COM1**.

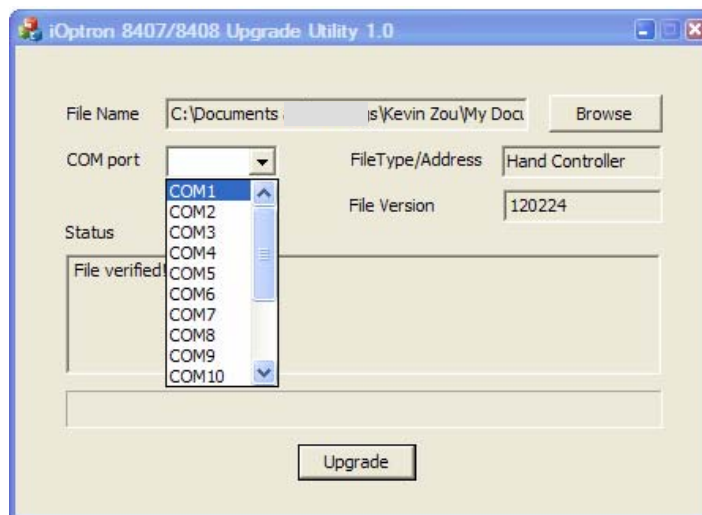

(8) Click on **Upgrade** button to start the process;

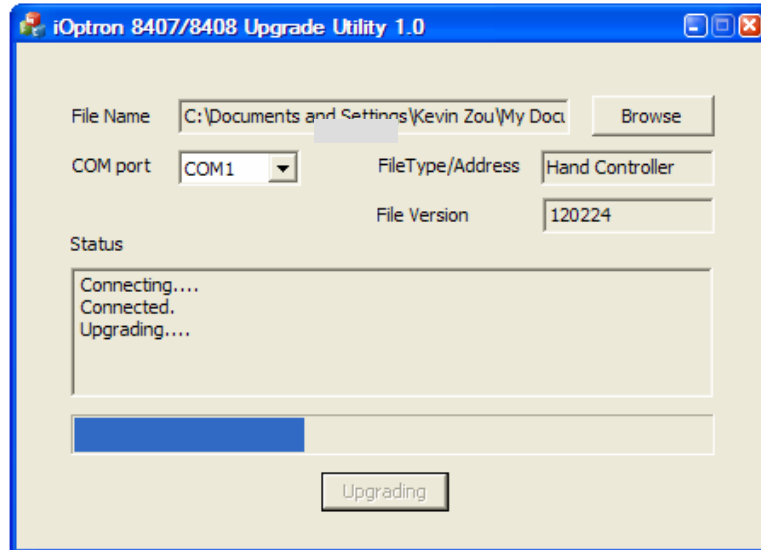

(9) After the firmware upgraded successfully, Exit the Upgrade Utility program.

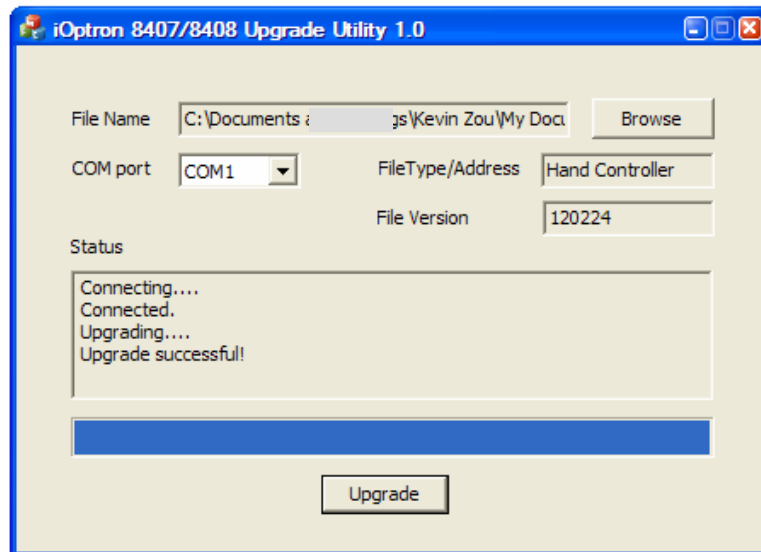

If the upgrade process was disrupted, wrong firmware is loaded, or the firmware does not successfully, just start over it again. Make sure a correct COM port is selected.

4. Upgrade iEQ45 main control board firmware:

- (1) Connect 8407 hand controller to the HBX port of an iEQ45 mount. Make sure the mount power is OFF;
- (2) Connect mount main board to your computer's RS232 port (or RS232 port of the USB2COM converter) using supplied RS232 cable;
- (3) Locate download software and click on **Upgrade Utility.exe**;
- (4) Click on **Browse** in iOptron Upgrade Utility window. Select main board firmware iEQ45_Main_VerXXXXXX and click **Open**

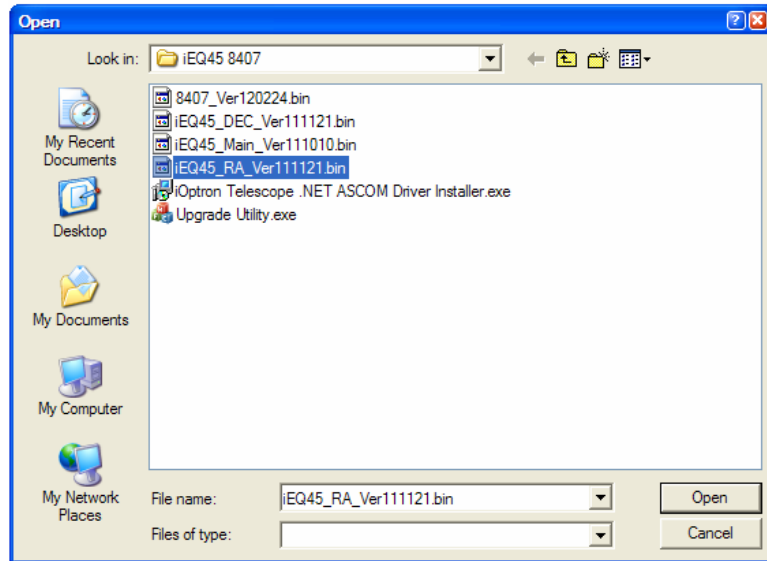

- (5) Click on pull down menu of the COM port and select the COM port number. Here is **COM1**. Click on **Upgrade** button. Switch the ON/OFF button to turn the mount power on. The upgrading process will begin. After the firmware upgraded successfully, exit the Upgrade Utility program.

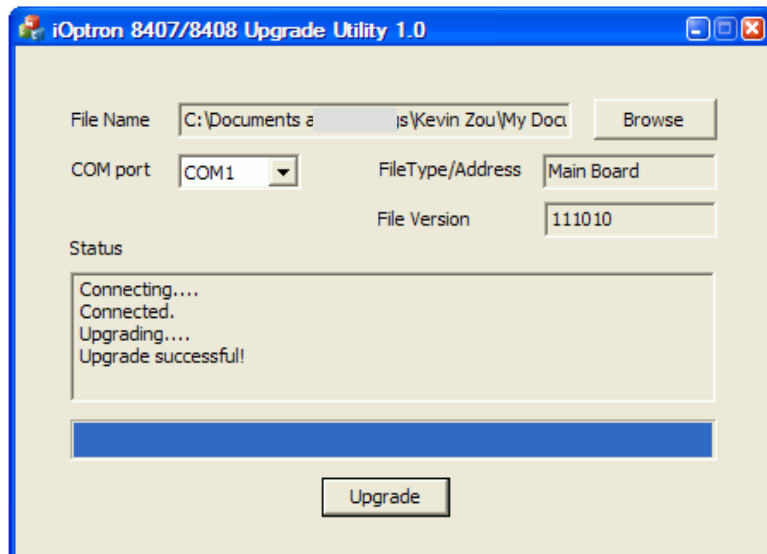

5. Upgrade iEQ45 R.A. or DEC control board firmware:

- (1) Connect 8407 hand controller to the HBX port of an iEQ45 mount. Make sure the mount power is OFF;
- (2) Connect mount main board to your computer's RS232 port (or RS232 port of the USB2COM converter) using supplied RS232 cable;
- (3) Switch the ON/OFF button to turn the mount power on.
- (4) From your hand controller, press **MENU** button, select **Set Up Controller → Upgrade RA & DEC**, enter password (9999), then select **Upgrade R. A. Board** or **Upgrade DEC Board**;
- (5) Locate download software and click on **Upgrade Utility.exe**:
- (6) Click on **Browse** in iOptron Upgrade Utility window. Select R.A. or DEC board firmware, such as iEQ45_RA_VerXXXXXX and click **Open**;

(7) Click on pull down menu of the COM port and select the COM port number. Here is **COM1**. Click on **Upgrade** button. The upgrading process will begin.

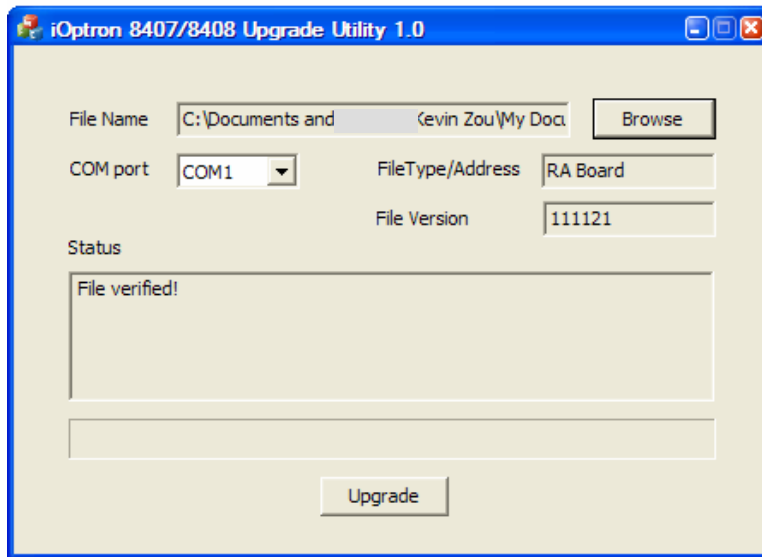

(8) After the firmware upgrade finished, exit the Upgrade Utility program.

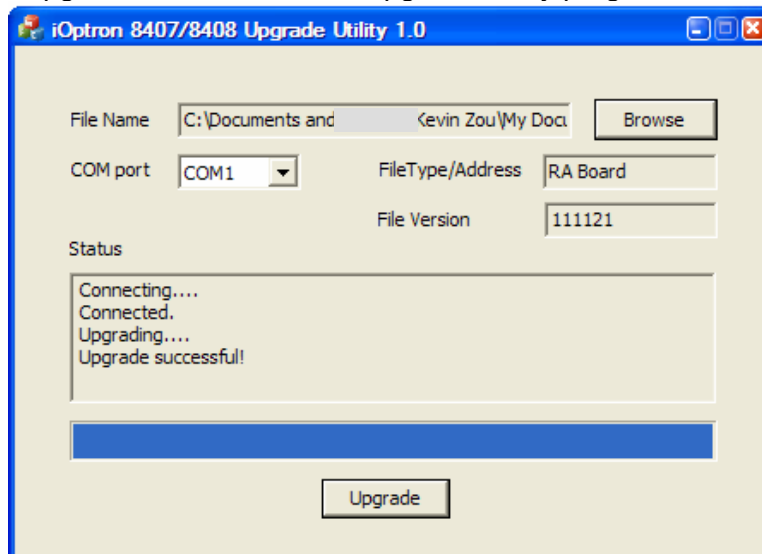

Appendix D. Computer Control an iEQ45 Mount

The iEQ45 mount can be connected to a computer using supplied RS232 cable. A RS232 to USB adapter (not included) is needed if your computer does not have a serial port, like most of the laptops on the market today. Follow the adapter instructions to install the adapter driver.

When the communication between the mount and computer has been established, the mount can be controlled via ASCOM protocol.

To control the mount via ASCOM protocol, you need:

1. Download and install ASCOM Platform from <http://www.ascom-standards.org/>. Make sure your PC meet the software requirement. Refer to the ascom-standards website for details.
2. Download and install latest **iOptron Telescope ASCOM.NET Drive (NOT iOptron Telescope ASCOM Driver 2.10)** from iOptron website.
3. Planetarium software that supports ASCOM protocol. Follow software instructions to select the iOptron Telescope.

Please refer to iOptron website, www.iOptron.com, under Support Directory/iEQ45 with 8407 Hand Controller, for more detail.

iEQ45 mount can also be directly controlled by other third party software and accessories, such as iPhone, iPad, Android operated smart phone and iMac. Please contact the software developer companies for more information.

Appendix E. Go2Nova[®] Star List

Messier Catalog

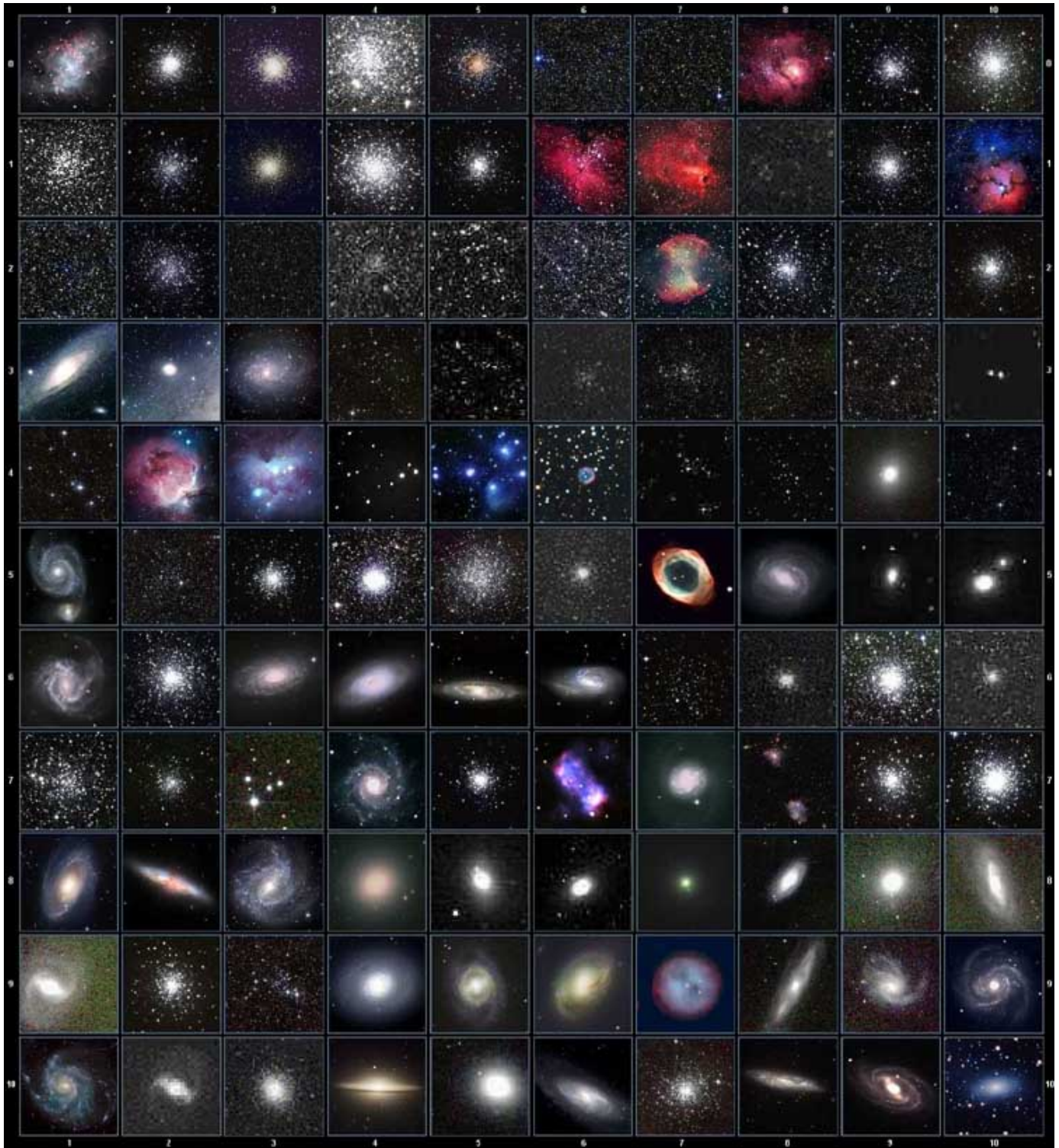

This table is licensed under the [GNU Free Documentation License](#). It uses material from the [Wikipedia article List of Messier objects](#)

Named Star List

001 Acamar	050 Asellus Australis	099 Kaus Media	148 Rastaba
002 Achernar	051 Asellus Borealis	100 Keid	149 Regulus
003 Acrux	052 Aspidiske	101 Kitalpha	150 Rigel
004 Acubens	053 Atik	102 Kochab	151 Rigel Kentaurus
005 Adhafera	054 Atlas	103 Kornephoros	152 Ruchbah
006 Adhara	055 Atria	104 Kurhah	153 Rukbat
007 Al Na'ir	056 Avoir	105 Lesath	154 Sabik
008 Albali	057 Azha	106 Maia	155 Sadachbia
009 Alberio	058 Baten Kaitos	107 Marfik	156 Sadalbari
010 Alchibar	059 Beid	108 Markab	157 Sadalmelik
011 Alcor	060 Bellatrix	109 Matar	158 Sadalsuud
012 Alcyone	061 Betelgeuse	110 Mabsuta	159 Sadr
013 Aldebaran	062 Biham	111 Megrez	160 Saiph
014 Alderamin	063 Canopus	112 Meissa	161 Scheat
015 Alfirk	064 Capella	113 Mekbuda	162 Schedar
016 Algedi	065 Caph	114 Menkalinan	163 Seginus
017 Algenib	066 Castor	115 Menkar	164 Shaula
018 Algiebra	067 Celabrai	116 Menkent	165 Sheiak
019 Algol	068 Celaeno	117 Menkib	166 Sheratan
020 Algorab	069 Chara	118 Merak	167 Sirius
021 Alhena	070 Chertan	119 Merope	168 Skat
022 Alioth	071 Cor Caroli	120 Mesartim	169 Spica
023 Alkaid	072 Cursa	121 Miaplacidus	170 Sterope
024 Alkalurops	073 Dabih	122 Mintaka	171 Sulafat
025 Alkes	074 Deneb	123 Mira	172 Syrma
026 Almach	075 Deneb Algedi	124 Mirach	173 Talitha
027 Alnasl	076 Deneb Kaitos	125 Mirfak	174 Tania Australis
028 Alnilam	077 Denebola	126 Mirzam	175 Tania Borealis
029 Alnitak	078 Dubhe	127 Mizar	176 Tarazed
030 Alphard	079 Edasich	128 Muphrid	177 Taygeta
031 Alphecca	080 Electra	129 Muscida	178 Thuban
032 Alpheratz	081 Elnath	130 Nashira	179 Unukalhai
033 Alrakis	082 Eltanin	131 Nekkar	180 Vega
034 Alrescha	083 Enif	132 Nihal	181 Vindemiatrix
035 Alshain	084 Errai	133 Nunki	182 Wasat
036 Altair	085 Fomalhaut	134 Nusakan	183 Wazn
037 Altais	086 Furud	135 Peacock	184 Yed Posterior
038 Alterf	087 Gacrux	136 Phact	185 Yed Prior
039 Aludra	088 Giasar	137 Phecda	186 Zaniah
040 Alula Australis	089 Gienah	138 Pherkad	187 Zaurak
041 Alula Borealis	090 Gomeisa	139 Pleione	188 Zavijava
042 Alya	091 Graffias	140 Polaris	189 Zosma
043 Ancha	092 Groombridge 1830	141 Pollux	190 Zubenelgenubi
044 Ankaa	093 Grumium	142 Porrima	191 Zubeneschamali
045 Antares	094 Hamal	143 Procyon	192 Barnard's Star
046 Arcturus	095 Homan	144 Propus	193 Kapteyn's Star
047 Arkab	096 Izar	145 Rassalas	194 Kruger 60
048 Arneb	097 Kaus Australis	146 Rasagethi	195 Luyten's Star
049 Ascella	098 Kaus Borealis	147 Rasalhague	

Modern Constellations

No.	Constellation	Abbreviation
1	Andromeda	And
2	Antlia	Ant
3	Apus	Aps
4	Aquarius	Aqr
5	Aquila	Aql
6	Ara	Ara
7	Aries	Ari
8	Auriga	Aur
9	Boötes	Boo
10	Caelum	Cae
11	Camelopardalis	Cam
12	Cancer	Cnc
13	Canes Venatici	CVn
14	Canis Major	CMa
15	Canis Minor	CMi
16	Capricornus	Cap
17	Carina	Car
18	Cassiopeia	Cas
19	Centaurus	Cen
20	Cepheus	Cep
21	Cetus	Cet
22	Chamaeleon	Cha
23	Circinus	Cir
24	Columba	Col
25	Coma Berenices	Com
26	Corona Australis	CrA
27	Corona Borealis	CrB
28	Corvus	Crv
29	Crater	Crt
30	Crux	Cru
31	Cygnus	Cyg
32	Delphinus	Del
33	Dorado	Dor
34	Draco	Dra
35	Equuleus	Equ
36	Eridanus	Eri
37	Fornax	For
38	Gemini	Gem
39	Grus	Gru
40	Hercules	Her
41	Horologium	Hor
42	Hydra	Hya
43	Hydrus	Hyi
44	Indus	Ind

No.	Constellation	Abbreviation
45	Lacerta	Lac
46	Leo	Leo
47	Leo Minor	LMi
48	Lepus	Lep
49	Libra	Lib
50	Lupus	Lup
51	Lynx	Lyn
52	Lyra	Lyr
53	Mensa	Men
54	Microscopium	Mic
55	Monoceros	Mon
56	Musca	Mus
57	Norma	Nor
58	Octans	Oct
59	Ophiuchus	Oph
60	Orion	Ori
61	Pavo	Pav
62	Pegasus	Peg
63	Perseus	Per
64	Phoenix	Phe
65	Pictor	Pic
66	Pisces	Psc
67	Piscis Austrinus	PsA
68	Puppis	Pup
69	Pyxis	Pyx
70	Reticulum	Ret
71	Sagitta	Sge
72	Sagittarius	Sgr
73	Scorpius	Sco
74	Sculptor	Scl
75	Scutum	Sct
76	Serpens	Ser
77	Sextans	Sex
78	Taurus	Tau
79	Telescopium	Tel
80	Triangulum	Tri
81	Triangulum Australe	TrA
82	Tucana	Tuc
83	Ursa Major	UMa
84	Ursa Minor	UMi
85	Vela	Vel
86	Virgo	Vir
87	Volans	Vol
88	Vulpecula	Vul

Deep Sky Object List

ID No.	OBJECT	NGC #	Messier#	IC#	A(Abell)	U(UGC)	ID No.	OBJECT	NGC #	Messier#	IC#	A(Abell)	U(UGC)
1	Andromeda Galaxy	224	31				31	Hind's Variable Nebula	1555				
2	Barnards Galaxy	6822					32	Hubble's Variable Nebula	2261				
3	Beehive Cluster	2632	44				33	Integral Sign Galaxy					3697
4	Blackeye Galaxy	4926	64				34	Jewel Box Cluster	4755				
5	Blinking Planetary Nebula	6826					35	Keyhole Nebula	3372				
6	Blue Flash Nebula	6905					36	Lagoon Nebula	6523	8			
7	Blue Planetary	3918					37	Little Gem	6445				
8	Blue Snowball Nebula	7662					38	Little Gem Nebula	6818				
9	Box Nebula	6309					39	Little Ghost Nebula	6369				
10	Bubble Nebula	7635					40	North American Nebula	7000				
11	Bipolar Nebula	6302					41	Omega Nebula	6618	17			
12	Butterfly Cluster	6405	6				42	Orion Nebula	1976	42			
13	California Nebula	1499					43	Owl Nebula	3587	97			
14	Cat's Eye Nebula	6543					44	Pelican Nebula			5070		
15	Cocoon Nebula			5146			45	Phantom Streak Nebula	6741				
16	Cone Nebula	2264					46	Pinwheel Galaxy	598	33			
17	Cork Nebula	650-51	76				47	Pleiades		45			
18	Crab Nebula	1952	1				48	Ring Nebula	6720	57			
19	Crescent Nebula	6888					49	Ring Tail Galaxy	4038				
20	Draco Dwarf					10822	50	Rosette Nebula	2237				
21	Duck Nebula	2359					51	Saturn Nebula	7009				
22	Dumbbell Nebula	6853	27				52	Sextans B Dwarf					5373
23	Eagle Nebula		16				53	Small Magellanic Cloud	292				
24	Eight-Burst Nebula	3132					54	Sombrero Galaxy	4594	104			
25	Eskimo Nebula	2392					55	Spindle Galaxy	3115				
26	Flaming Star Nebula			405			56	Tank Track Nebula	2024				
27	Ghost of Jupiter	3242					57	Trifid Nebula	6514	20			
28	Great Cluster	6205	13				58	Ursa Minor Dwarf					9749
29	Helix Nebula	7293					59	Whirlpool Galaxy	5194	51			
30	Hercules Galaxy Cluster				2151		60	Wild Duck Cluster	6705	11			

Double Star List

No.	Object	Const	Sep.	Magitude	SAO	Comm. Name
1	Gam	And	9.8	2.3 / 5.1	37734	Almaak
2	Pi	And	35.9	4.4 / 8.6	54033	
3	Bet	Aql	12.8	3.7 / 11	125235	Alshain
4	11	Aql	17.5	5.2 / 8.7	104308	
5	15	Aql	34	5.5 / 7.2	142996	
6	E2489	Aql	8.2	5.6 / 8.6	104668	
7	57	Aql	36	5.8 / 6.5	143898	
8	Zet	Aqr	2.1	4.3 / 4.5	146108	
9	94	Aqr	12.7	5.3 / 7.3	165625	
10	41	Aqr	5.1	5.6 / 7.1	190986	
11	107	Aqr	6.6	5.7 / 6.7	165867	
12	12	Aqr	2.5	5.8 / 7.3	145065	
13	Tau	Aqr	23.7	5.8 / 9.0	165321	
14	Gam	Ari	7.8	4.8 / 4.8	92681	Mesartim
15	Lam	Ari	37.8	4.8 / 6.7	75051	
16	The	Aur	3.6	2.6 / 7.1	58636	
17	Nu	Aur	55	4.0 / 9.5	58502	
18	Ome	Aur	5.4	5.0 / 8.0	57548	
19	Eps	Boo	2.8	2.5 / 4.9	83500	Izar
20	Del	Boo	105	3.5 / 7.5	64589	
21	Mu 1	Boo	108	4.3 / 6.5	64686	Alkalurops
22	Tau	Boo	4.8	4.5 / 11	100706	
23	Kap	Boo	13.4	4.6 / 6.6	29046	
24	Xi	Boo	6.6	4.7 / 6.9	101250	
25	Pi	Boo	5.6	4.9 / 5.8	101139	
26	lot	Boo	38	4.9/7.5/13	29071	
27	E1835	Boo	6.2	5.1 / 6.9	120426	
28	44	Boo	2.2	5.3 / 6.2	45357	
29		Cam	2.4	4.2 / 8.5	24054	
30	32	Cam	21.6	5.3 / 5.8	2102	
31	Alp 2	Cap	6.6	3.6 / 10	163427	Secunda giedi
32	Alp 1	Cap	45	4.2 / 9.2	163422	Prima giedi
33	Pi	Cap	3.4	5.2 / 8.8	163592	
34	Omi	Cap	21	5.9 / 6.7	163625	
35	Alp	Cas	64.4	2.2 / 8.9	21609	Shedir

No.	Object	Const	Sep.	Magitude	SAO	Comm. Name
36	Eta	Cas	12.9	3.5 / 7.5	21732	Achird
37	lot	Cas	2.3	4.7/7.0/8.2	12298	
38	Psi	Cas	25	4.7 / 8.9	11751	
39	Sig	Cas	3.1	5.0 / 7.1	35947	
40	E3053	Cas	15.2	5.9 / 7.3	10937	
41	3	Cen	7.9	4.5 / 6.0	204916	
42	Bet	Cep	13.6	3.2 / 7.9	10057	Alfirk
43	Del	Cep	41	3.5 / 7.5	34508	
44	Xi	Cep	7.6	4.3 / 6.2	19827	Al kurhah
45	Kap	Cep	7.4	4.4 / 8.4	9665	
46	Omi	Cep	2.8	4.9 / 7.1	20554	
47	E2840	Cep	18.3	5.5 / 7.3	33819	
48	E2883	Cep	14.6	5.6 / 7.6	19922	
49	Gam	Cet	2.8	5.0 / 7.7	110707	Kaffaljidhma
50	37	Cet	50	5.2 / 8.7	129193	
51	66	Cet	16.5	5.7 / 7.5	129752	
52	Eps	CMa	7.5	1.5 / 7.4	172676	Adhara
53	Tau	CMa	8.2	4.4/10/11	173446	
54	145	CMa	25.8	4.8 / 6.8	173349	
55	Mu	CMa	2.8	5.0 / 7.0	152123	
56	Nu 1	CMa	17.5	5.8 / 8.5	151694	
57	lot	Cnc	30.5	4.2 / 6.6	80416	
58	Alp	Cnc	11	4.3 / 12	98267	Acubens
59	Zet	Cnc	6	5.1 / 6.2	97646	
60	24	Com	20.6	5.0 / 6.6	100160	
61	35	Com	1.2	5.1/7.2/9.1	82550	
62	2	Com	3.7	5.9 / 7.4	82123	
63	Zet	CrB	6.1	5.0 / 6.0	64833	
64	Gam	Crt	5.2	4.1 / 9.6	156661	
65	Del	Crv	24.2	3.0 / 9.2	157323	Algorab
66	Alp	CVn	19.4	2.9 / 5.5	63257	Cor caroli
67	25	CVn	1.8	5.0 / 6.9	63648	
68	2	CVn	11.4	5.8 / 8.1	44097	
69	Gam	Cyg	41	2.2 / 9.5	49528	Sadr
70	Del	Cyg	2.5	2.9 / 6.3	48796	

No.	Object	Const	Sep.	Magitude	SAO	Comm. Name
71	Bet	Cyg	34.4	3.1 / 5.1	87301	Albireo
72	Omi 1	Cyg	107	3.8 / 6.7	49337	
73	52	Cyg	6.1	4.2 / 9.4	70467	
74	Ups	Cyg	15.1	4.4 / 10	71173	
75	Mu	Cyg	1.9	4.7 / 6.1	89940	
76	Psi	Cyg	3.2	4.9 / 7.4	32114	
77	17	Cyg	26	5.0 / 9.2	68827	
78	61	Cyg	30.3	5.2 / 6.0	70919	
79	49	Cyg	2.7	5.7 / 7.8	70362	
80	E2762	Cyg	3.4	5.8 / 7.8	70968	
81	E2741	Cyg	1.9	5.9 / 7.2	33034	
82	Gam	Del	9.6	4.5 / 5.5	106476	
83	Eta	Dra	5.3	2.7 / 8.7	17074	
84	Eps	Dra	3.1	3.8 / 7.4	9540	Tyl
85	47	Dra	34	4.8 / 7.8	31219	
86	Nu	Dra	61.9	4.9 / 4.9	30450	
87	Psi	Dra	30.3	4.9 / 6.1	8890	
88	26	Dra	1.7	5.3 / 8.0	17546	
89	16&17	Dra	90	5.4/5.5/6.4	30012	
90	Mu	Dra	1.9	5.7 / 5.7	30239	
91	40/41	Dra	19.3	5.7 / 6.1	8994	
92	1	Equ	10.7	5.2 / 7.3	126428	
93	The	Eri	4.5	3.4 / 4.5	216114	Acamar
94	Tau 4	Eri	5.7	3.7 / 10	168460	
95	Omi 2	Eri	8.3	4.4/9.5/11	131063	Keid
96	32	Eri	6.8	4.8 / 6.1	130806	
97	39	Eri	6.4	5.0 / 8.0	149478	
98	Alp	For	5.1	4.0 / 6.6	168373	Fornacis
99	Ome	For	10.8	5.0 / 7.7	167882	
100	Alp	Gem	3.9	1.9 / 2.9	60198	Castor
101	Del	Gem	5.8	3.5 / 8.2	79294	Wasat
102	Lam	Gem	9.6	3.6 / 11	96746	
103	Kap	Gem	7.1	3.6 / 8.1	79653	
104	Zet	Gem	87	3.8/10/8.0	79031	Mekbuda
105	38	Gem	7.1	4.7 / 7.7	96265	

No.	Object	Const	Sep.	Magitude	SAO	Comm. Name
106	Del	Her	8.9	3.1 / 8.2	84951	Sarin
107	Mu	Her	34	3.4 / 9.8	85397	
108	Alp	Her	4.6	3.5 / 5.4	102680	Rasalgethi
109	Gam	Her	42	3.8 / 9.8	102107	
110	Rho	Her	4.1	4.6 / 5.6	66001	
111	95	Her	6.3	5.0 / 5.2	85647	
112	Kap	Her	27	5.0 / 6.2	101951	
113	E2063	Her	16.4	5.7 / 8.2	46147	
114	100	Her	14.3	5.9 / 5.9	85753	
115	54	Hya	8.6	5.1 / 7.1	182855	
116	HN69	Hya	10.1	5.9 / 6.8	181790	
117	Eps	Hyd	2.7	3.4 / 6.8	117112	
118	The	Hyd	29.4	3.9 / 10	117527	
119	N	Hyd	9.4	5.6 / 5.8	179968	
120		Lac	28.4	4.5 / 10	72155	
121	8	Lac	22	5.7/6.5/10	72509	
122	Gam 1	Leo	4.4	2.2 / 3.5	81298	Algieba
123	lot	Leo	1.7	4.0 / 6.7	99587	
124	54	Leo	6.6	4.3 / 6.3	81583	
125	Gam	Lep	96	3.7 / 6.3	170757	
126	lot	Lep	12.8	4.4 / 10	150223	
127	Kap	Lep	2.6	4.5 / 7.4	150239	
128	h3752	Lep	3.2	5.4 / 6.6	170352	
129	lot	Lib	57.8	4.5 / 9.4	159090	
130		Lib	23	5.7 / 8.0	183040	
131	Mu	Lib	1.8	5.8 / 6.7	158821	
132	Eta	Lup	15	3.6 / 7.8	207208	
133	Xi	Lup	10.4	5.3 / 5.8	207144	
134	38	Lyn	2.7	3.9 / 6.6	61391	
135	12	Lyn	1.7	5.4/6.0/7.3	25939	
136	19	Lyn	14.8	5.8 / 6.9	26312	
137	Bet	Lyr	46	3.4 / 8.6	67451	Sheliak
138	Zet	Lyr	44	4.3 / 5.9	67321	
139	Eta	Lyr	28.1	4.4 / 9.1	68010	Aldafar
140	Eps 1	Lyr	2.6	5.0 / 6.1	67309	Double dbl1

No.	Object	Const	Sep.	Magitude	SAO	Comm. Name
141	Eps 2	Lyr	2.3	5.2 / 5.5	67315	Double dbl2
142	Alp	Mic	20.5	5.0 / 10	212472	
143	Zet	Mon	32	4.3 / 10	135551	
144	Eps	Mon	13.4	4.5 / 6.5	113810	
145	Bet	Mon	7.3	4.7/4.8/6.1	133316	
146	15	Mon	2.8	4.7 / 7.5	114258	
147	70	Oph	4.5	4.0 / 5.9	123107	
148	67	Oph	55	4.0 / 8.6	123013	
149	Lam	Oph	1.5	4.2 / 5.2	121658	Marfic
150	Xi	Oph	3.7	4.4 / 9.0	185296	
151	36	Oph	4.9	5.1 / 5.1	185198	
152	Tau	Oph	1.7	5.2 / 5.9	142050	
153	Rho	Oph	3.1	5.3 / 6.0	184382	
154	39	Oph	10.3	5.4 / 6.9	185238	
155	Bet	Ori	9.5	0.1 / 6.8	131907	Rigel
156	Del	Ori	53	2.2 / 6.3	132220	Mintaka
157	lot	Ori	11.3	2.8 / 6.9	132323	Nair al saif
158	Lam	Ori	4.4	3.6 / 5.5	112921	Meissa
159	Sig	Ori	13	3.8/7.2/6.5	132406	
160	Rho	Ori	7.1	4.5 / 8.3	112528	
161	E747	Ori	36	4.8 / 5.7	132298	
162	1	Peg	36.3	4.1 / 8.2	107073	
163	Eps	Per	8.8	2.9 / 8.1	56840	
164	Zet	Per	12.9	2.9 / 9.5	56799	Atik
165	Eta	Per	28.3	3.3 / 8.5	23655	Miram in bevar
166	The	Per	18.3	4.1 / 10	38288	
167	E331	Per	12.1	5.3 / 6.7	23765	
168	Del	PsA	5.1	4.2 / 9.2	214189	
169	lot	PsA	20	4.3 / 11	213258	
170	Bet	PsA	30.3	4.4 / 7.9	213883	
171	Gam	PsA	4.2	4.5 / 8.0	214153	
172	Eta	PsA	1.7	5.8 / 6.8	190822	
173	Alp	Psc	1.8	4.2 / 5.2	110291	Alrisha
174	55	Psc	6.5	5.4 / 8.7	74182	
175	Psi	Psc	30	5.6 / 5.8	74483	

No.	Object	Const	Sep.	Magitude	SAO	Comm. Name
176	Zet	Psc	23	5.6 / 6.5	109739	
177	Kap	Pup	9.9	4.5 / 4.7	174199	
178	Eta	Pup	9.6	5.8 / 5.9	174019	
179	Eps	Scl	4.7	5.4 / 8.6	167275	
180	Bet	Sco	13.6	2.6 / 4.9	159682	Graffias
181	Sig	Sco	20	2.9 / 8.5	184336	Alniyat
182	Nu	Sco	41	4.2 / 6.1	159764	Jabbah
183	2	Sco	2.5	4.7 / 7.4	183896	
184		Sco	23	5.4 / 6.9	207558	
185	Hn39	Sco	5.4	5.9 / 6.9	184369	
186	12	Sco	3.9	5.9 / 7.9	184217	
187	Bet	Ser	31	3.7 / 9.0	101725	
188	Del	Ser	4.4	4.2 / 5.2	101624	
189	Nu	Ser	46	4.3 / 8.5	160479	
190	The	Ser	22.3	4.5 / 5.4	124070	Alya
191	59	Ser	3.8	5.3 / 7.6	123497	
192	Zet	Sge	8.5	5.0 / 8.8	105298	
193	Eta	Sgr	3.6	3.2 / 7.8	209957	
194		Sgr	5.5	5.2 / 6.9	209553	
195	Phi	Tau	52	5.0 / 8.4	76558	
196	Chi	Tau	19.4	5.7 / 7.6	76573	
197	118	Tau	4.8	5.8 / 6.6	77201	
198	6	Tri	3.9	5.3 / 6.9	55347	
199	Zet	UMa	14	2.4 / 4.0	28737	Mizar
200	Nu	UMa	7.2	3.5 / 9.9	62486	Alula borealis
201	23	UMa	23	3.6 / 8.9	14908	
202	Ups	UMa	11.6	3.8 / 11	27401	
203	Xi	UMa	1.8	4.3 / 4.8	62484	Alula australia
204	Sig 2	UMa	3.9	4.8 / 8.2	14788	
205	57	UMa	5.4	5.4 / 5.4	62572	
206	Alp	UMi	18.4	2.0 / 9.0	308	Polaris
207	Gam	Vir	1.4	3.5 / 3.5	138917	Porrima
208	The	Vir	7.1	4.4 / 9.4	139189	
209	Phi	Vir	4.8	4.8 / 9.3	139951	
210	84	Vir	2.9	5.7 / 7.9	120082	

IOPTRON TWO YEAR TELESCOPE, MOUNT, AND CONTROLLER WARRANTY

A. iOptron warrants your telescope, mount, or controller to be free from defects in materials and workmanship for two years. iOptron will repair or replace such product or part which, upon inspection by iOptron, is found to be defective in materials or workmanship. As a condition to the obligation of iOptron to repair or replace such product, the product must be returned to iOptron together with proof-of-purchase satisfactory to iOptron.

B. The Proper Return Merchant Authorization Number must be obtained from iOptron in advance of return. Call iOptron at 1.781.569.0200 to receive the RMA number to be displayed on the outside of your shipping container. All returns must be accompanied by a written statement stating the name, address, and daytime telephone number of the owner, together with a brief description of any claimed defects. Parts or product for which replacement is made shall become the property of iOptron.

The customer shall be responsible for all costs of transportation and insurance, both to and from the factory of iOptron, and shall be required to prepay such costs.

iOptron shall use reasonable efforts to repair or replace any telescope, mount, or controller covered by this warranty within thirty days of receipt. In the event repair or replacement shall require more than thirty days, iOptron shall notify the customer accordingly. iOptron reserves the right to replace any product which has been discontinued from its product line with a new product of comparable value and function.

This warranty shall be void and of no force of effect in the event a covered product has been modified in design or function, or subjected to abuse, misuse, mishandling or unauthorized repair. Further, product malfunction or deterioration due to normal wear is not covered by this warranty.

IOPTRON DISCLAIMS ANY WARRANTIES, EXPRESS OR IMPLIED, WHETHER OF MERCHANTABILITY OF FITNESS FOR A PARTICULAR USE, EXCEPT AS EXPRESSLY SET FORTH HERE. THE SOLE OBLIGATION OF IOPTRON UNDER THIS LIMITED WARRANTY SHALL BE TO REPAIR OR REPLACE THE COVERED PRODUCT, IN ACCORDANCE WITH THE TERMS SET FORTH HERE. IOPTRON EXPRESSLY DISCLAIMS ANY LOST PROFITS, GENERAL, SPECIAL, INDIRECT OR CONSEQUENTIAL DAMAGES WHICH MAY RESULT FROM BREACH OF ANY WARRANTY, OR ARISING OUT OF THE USE OR INABILITY TO USE ANY IOPTRON PRODUCT. ANY WARRANTIES WHICH ARE IMPLIED AND WHICH CANNOT BE DISCLAIMED SHALL BE LIMITED IN DURATION TO A TERM OF TWO YEARS FROM THE DATE OF ORIGINAL RETAIL PURCHASE.

Some states do not allow the exclusion or limitation of incidental or consequential damages or limitation on how long an implied warranty lasts, so the above limitations and exclusions may not apply to you.

This warranty gives you specific legal rights, and you may also have other rights which vary from state to state.

iOptron reserves the right to modify or discontinue, without prior notice to you, any model or style telescope.

If warranty problems arise, or if you need assistance in using your telescope, mount, or controller contact:

iOptron Corporation
Customer Service Department
6E Gill Street
Woburn, MA 01801
www.ioptron.com
support@ioptron.com
Tel. (781)569-0200
Fax. (781)935-2860
Monday-Friday 9AM-5PM EST

NOTE: This warranty is valid to U.S.A. and Canadian customers who have purchased this product from an authorized iOptron dealer in the U.S.A. or Canada or directly from iOptron. Warranty outside the U.S.A. and Canada is valid only to customers who purchased from an iOptron Distributor or Authorized iOptron Dealer in the specific country. Please contact them for any warranty.